

AN
UNLIMITED
PROMOTIONAL
WORLD



RECYCLED
ALUMINIUM



+200 NOVELTIES

4206 CEDRO | PG.212



INDEX

12

TECHNOLOGY

PG. 12—69

70

WRITING & OFFICE

PG. 70—117

118

BAGS & TRAVEL

PG. 118—191

192

EATING & DRINKWARE

PG. 192—237

238

HOME, GIFTS & PREMIUM

PG. 238—269

270

TOOLS & PET CARE

PG. 270—287

288

WINTER & RAINY DAYS

PG. 288—299

300

SUBLIMATION

PG. 300—315

316

PARTY & EVENTS

PG. 316—331

332

SUMMER

PG. 332—343

344

LEISURE & SPORT

PG. 344—359

360

PERSONAL CARE

PG. 360—377

378

CHRISTMAS

PG. 378—385

386

MATERIALS

PG. 386—395

396

INDEX

PG. 396—408

1216_DUMAI ◀
PG. 364



▶ 1126_PODOX
PG. 367

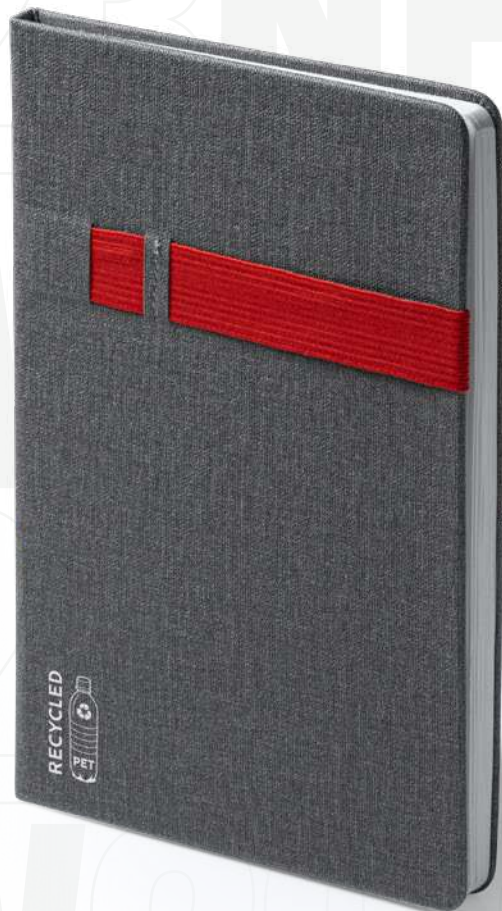

▶ 7971_SIKAS
PG. 104



▲ 3045_FOLK
PG. 16



7973_ALVIK ◀
PG. 90



3991_BRICO ◀
PG. 272



▲ **3042_TANGO**
PG. 24



▶ **3985_TEIDE**
PG. 203



▶ **3984_SORBY**
PG. 271



▶ **4203_SAOKO**
PG. 214

7026_KARIN
PG. 354



▶ **4211_COIBA**
PG. 211



3114_KEROS
PG. 307



▲ **7092_AURA**
PG. 349



1040_VIZA
PG. 254



7186_VOLANO ◀
PG. 120

8105_BARI
PG. 333



SERVIÇO DE IMPRESSÃO

Personalize qualquer produto com o nosso serviço exclusivo de impressão. Colocamos à sua disposição as técnicas de marcação mais avançadas do mercado.



Direct printing



Embroidery



Silk-screen printing

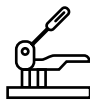

Transfers



Laser



Sublimation



and more



OUR CERTIFICATES



COMPROMISSO COM O MEIO AMBIENTE

Colocamos à sua disposição uma grande seleção de produtos elaborados com materiais naturais e reciclados, para contribuir com a responsabilidade de termos um mundo mais sustentável.



NATURAL JUTE



BAMBOO



RECYCLED LEATHER



RECYCLED ALUMINIUM



RECYCLED PAPER



RECYCLED ABS



RECYCLED PET



BAMBOO FIBER



WHEAT FIBER



TRITAN



LIMESTONE CEMENT



PLA



NATURAL WOOD



NATURAL CORK



BOROSILICATE GLASS



HEMP



RECYCLED COTTON



ORGANIC COTTON



RECYCLED CARDBOARD

MATERIALS GUIDE PG.388

CUIDAMOS DA APRESENTAÇÃO

Uma imagem vale mais que mil palavras. Por isso, cuidamos até ao mínimo detalhe da apresentação dos nossos artigos.

Aplicamos gráficos exclusivos em cada um deles, conferindo-lhes um valor exclusivo e diferenciado.







THE FAIRTRADE SEAL FAIR TRADE AND SUSTAINABILITY

The purchase of products made with certified fair trade cotton guarantees the support of cotton growers so that they improve their quality of life and their communities, contributing to protect people and the environment.

Fairtrade certification is intended to guarantee compliance with standards related to the production or supply of a product or ingredient. The presence of the seal also means that the product is fully traceable (it has been kept isolated from non-certified products) from the growing to the customer.



MADE ^{TO} ORDER



IT'S TIME TO DESIGN

¿Procura um produto 100% personalizado?

Realizamos **produções à medida em qualquer artigo**, tanto têxtil como brinde. Contamos com uma equipa necessária para realizar todo o tipo de projetos. Defina qual o tipo de produto que necessita e nós encarregamo-nos do resto.

TECHNOLOGY

RECYCLED ABS

LAMP | ALARM

NEW.



NEW NAMUR

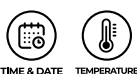

TIME & DATE TEMPERATURE

3044 Namur

Lâmpada Relógio despertador em ABS reciclado com modo de luz progressiva brilhante. Características: hora, data e temperatura. Luz LED em diversas cores. Cabo incluído. Apresentação em caixa de design ecológico.

18,5 x 14,4 x 6,6 cm

1/10

30

F(4), W



NEW.

NATURAL
CORK

BLUETOOTH



SPEAKER

FAST
CHARGERWIRELESS
CHARGER

TACTILE



TYPE C

2989 **Dravis**

Candeeiro de mesa com detalhes em cortiça, com carregador sem fios de 10W embutido na base e altifalante sem fios de 3W. Luz LED com três modos de relâmpago. Apresentação em caixa de design ecológico.

 33 x Ø12 cm

 1

 20

 F(1)

CORK SPEAKER LAMP







NEW.

2987 **Yarbo**

Carregador sem fios com estrutura em ABS reciclado e cortiça natural. Carga rápida de 10W. Ligação tipo C. Cabo incluído. Apresentação em caixa de design ecológico.

 10,4 x 2,1 x 10,4 cm

 1/50  100

 E(4), L2, W



NEW FOLK



NEW.



NATURAL CORK



RECYCLED ABS



BLUETOOTH



HANDS FREE



TACTILE



TYPE C



3045 Folk

Auriculares sem fios em ABS reciclado e cortiça natural. Caixa de carregamento com bateria recarregável. Painel de controlo tátil embutido no auricular. Função "mãos livres". Ligação tipo C. Cabo incluído. Apresentação em caixa de design ecológico.

6,7 x 5 x 3 cm

1/50

100

E(4), L2, W



3211 **Marco**

Altifalante com corpo em cortiça natural e membrana visível. Bluetooth 5.0. Potência 3W. Bateria recarregável. Cabo incluído. Apresentação em caixa de design ecológico.

4,6 x Ø7,90 cm 1/25 50
E(4), L1

WIRELESS CHARGING BASE



3031 **Sulac**

Carregador sem fios com corpo de cortiça natural e fibra de trigo. DC5V. Cabo incluído. Apresentação em caixa de design ecológico.

1,9 x Ø9 cm 1/50 100
E(4), L2, W



KEVEX

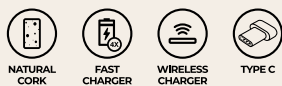

2994 Kevex

Carregador sem fio com porta-retrato em cortiça. Ideal para fotografias de 10 x 15 cm. Compatível com dispositivos de tecnologia sem fios. 10 W. Cabo incluído. Apresentação em caixa de design ecológico.

17,6 x 21 cm 1 40

E(1), L2



3032 Promet

Porta-lápis com carregador sem fios integrado. Feito de cortiça natural. Inclui 2 portas USB adicionais na parte de trás. 5W. Cabo incluído. Apresentação em caixa de design ecológico.

15,2 x 10,6 x 10,6 cm 1 20

F(1), L2



WIRELESS CHARGER

NATURAL
CORK2993 **Lebak**

Tapete de rato com superfície em cortiça natural e base antiderrapante.

22 x 18 cm

1/100

200

E(1), L2

LEBAK

NATURAL
CORKWIRELESS
CHARGER3030 **Alax**

Tapete de rato com carregador sem fios integrado. Superfície dobrável macia feita de cortiça natural com base antiderrapante. DC5V. Cabo incluído. Apresentação em caixa de design ecológico.

26 x 20,3 cm

1

50

F(1),L2

NEW.

NEW MARSAL



BAMBOO



FAST CHARGER



WIRELESS CHARGER



TYPE C



USB



2990 Marsal

Candeeiro de mesa de bambu dobrável com carregador sem fio 10W embutido. 25 luzes LED com 3 modos de acendimento e intensidade. Temporizador de luz de 1 a 2 horas. Apresentação em caixa de design ecológico.

 11 x 38,5 x 24,5 cm

 1

 20

 F(1), L2



3016 Celsius

Estação meteorológica com revestimento frontal de bambú natural. Função relógio com sensores de temperatura e umidade. Funciona com 2 pilhas AAA não incluídas. Apresentação em caixa de design eco.

8,6 x 12 x 2 cm 1/25 50

E(4),L1,W



3004 Kelvin

Estação meteorológica com revestimento frontal de bambú. Função Relógio, calendário e alarme com sensores de temperatura e umidade. Funciona com 2 pilhas AAA não incluídas. Apresentação em caixa design eco.

13 x 13 x 2,4 cm 1/20 40

E(4),L2,W



NEW.



2992 **Vulco**

Carregador sem fio com porta-retrato em bambu. Ideal para fotografias de 10 x 15 cm. Compatível com dispositivos de tecnologia sem fios. 10 W. Cabo incluído. Apresentação em caixa de design ecológico.

20,5 x 16,5 x 1,5 cm 1 40
E(4), L2

CLOCK & CHARGER

NEW.



3043 **Duncer**

Relógio de mesa com carregador sem fio de 5W em bambu. Características: hora, data, alarme e temperatura. Ligação tipo C. Cabo incluído. Apresentação em caixa de design ecológico.

16 x 3,7 x 7,5 cm 1 40
F(1), L2



ICARUS



WIRELESS CHARGER CLOCK

WIRELESS
CHARGER



ALARM

TIME & DATE

TEMPERATURE

3029 Icarus

Relógio com carregador sem fios feito de madeira MDF. Funções: hora, data, alarme e temperatura. 3 modos de iluminação. Cabo incluído. Apresentado em caixa de design ecológico.

16 x 2,9 x 7,5 cm  1  50

 E(4), L2, W





TANGO

HANDS
FREE

TYPE C



BAMBOO

3042 **Tango**

Auscultadores sem fio ajustáveis em bambu e tecido PET. Bandolete acolchoada e protetores auriculares. Controle tátil integrado com tecnologia estéreo. Função "mãos livres". Bateria recarregável. Cabo tipo C incluído. Apresentação em caixa de design ecológico.

 12,5 x 18 x 6,5 cm  1/15  30

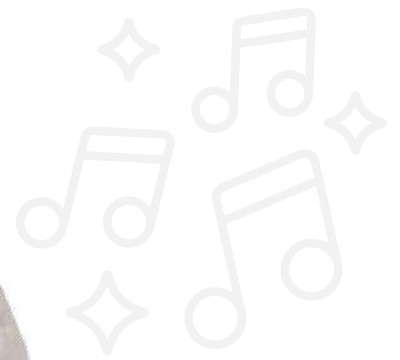

 F(1), L2

MOON



3197 Moon

Altifalante em formato de lua com suporte em madeira. Função de lâmpada. Saída 3W. Luz LED com diferentes modos de iluminação. Cabo incluído. Apresentação em caixa de design ecológico.

12 x 15 x 12 cm  1  20
 F(1), L2

SPEAKER | 3W | LED LIGHTS
 DIFFERENT LIGHT MODES

Cool light

Warm light



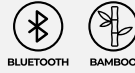

BLUETOOTH BAMBOO



3199 **Solum**

Altifalante sem fio com estrutura principal em bambu e alça de transporte elegante. Função "mãos livres". Saída 3W. Bateria recarregável. Cabo incluído. Apresentação em caixa de design ecológico.

10,6 x 8,1 x Ø6,90 cm 1 50

E(4), L1

BAMBOO SPEAKERS



BLUETOOTH BAMBOO CHANGING COLOR LIGHT



3195 **Ozcan**

Altifalante sem fio com estrutura principal em bambu. Luz LED multicores com 4 modos de iluminação. Saída 3W. Bateria recarregável e cabo incluídos. Apresentação em caixa de design ecológico.

10,6 x 10,6 x Ø6,40 cm 1/25 50

E(4), L1



BLUETOOTH HANDS FREE BAMBOO LINE IN

3206 **Kravisz**

Coluna sem fios com corpo em madeira e membrana visível. Ideal para marcação a laser. Bluetooth 3.0. Potência 3W. Bateria recarregável. Cabo incluído. Apresentação em caixa de design.

6 x 6 x 6 cm 1 50

E(4), L1





3306 **Nervo**

Auto-falante buetooth sem fio com corpo de bambú. Função rádio FM, mãos livres, slot de cartão Micro SD. 3W de potência. Bateria recarregável. Cabo incluído. Apresentação em caixa design eco.

5,1 x Ø6 cm 1/25 50
E(4), L1



3207 **Hardwell**

Sistema Alta-voz sem fio com corpo em ABS branco e bambu natural. Função de rádio FM, viva-voz, entrada para cartão mini SD e 3W de potência. Bateria recarregável. Inclui cabo. Apresentação em caixa de papel kraft

4,1 x Ø7,30 cm 1 50
E(2), L1



3210 **Alesso**

Coluna de som sem fios Bluetooth com corpo ABS, frontal em bambu natural e membrana visível. Inclui asa de transporte em couro sintético. Potência 3W. Bateria recarregável. Cabo incluído. Apresentação em caixa individual eco.

7,4 x 7 x 4,5 cm 1/25 50
E(4), L2



3026 **Blues**

Auriculares sem fio Bluetooth 5.0 com caixa de transporte em bambu natural. Botão multifunções integrado em ambos auriculares. Função mãos livres. Bateria recarregável. Cabo incluído. Apresentação em caixa individual eco.

7,8 x 3,2 x 3,2 cm 1/50 100
E(4), L1, W



3018 **Soyuz**

Carregador sem fio com corpo em ABS branco e superfície superior de bambu natural. Coloque o seu smartphone sobre ele e deixe-o carregar. Compatível com modelos com tecnologia wireless. DC5V. Inclui cabo. Caixa em papel kraft.

1 x Ø6 cm 1/50 200
E(4), L2, W



3355 **Rossum**

Bateria externa de 5.000 mAh, com corpo em ABS branco e superfície superior em bambu. Saída de corrente USB DC5V / 2.1A. Inclui cabo Micro USB. Caixa em papel kraft

10,1 x 1,5 x 6,3 cm 1/25 50
E(4), L2, W

NEW.

BAMBOO ACCESSORIES

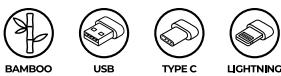

3036 **Gasly**

Porta-chaves com cabo de carregamento 3 em 1. Estrutura principal em bambu. Micro USB, Tipo C e ligação de iluminação. Apresentação em saco ecológico com janela.

4 x 0,8 x 10 cm 1/100 500
D(4), L1, W



3019 **Astro**

Cabo carregador 3 em 1. ABS e corpo de bambu natural. Micro USB, tipo C e conexão Lightning. Apresentação em saco ecológico com janela.

16,5 x 1 x 2,1 cm 1/100 400
D(1), L1



BAMBOO



USB

3023 Neptune

Porta USB com corpo de bambu natural e cabo em branco. Inclui 3 portas USB. Apresentação em caixa individual eco.

8,5 x 1,6 x 4 cm 1/50 200

D(4), L1, W

BAMBOO POWERBANK



WIRELESS CHARGER

TYPE C



BAMBOO



WIRELESS CHARGER



TYPE C



USB



3349 Misty

Carregador portátil 6.000 mAh com função de carregamento sem fio. Estrutura principal em bambu natural. Saída DC5V/2.1A. DC5V sem fio. Cabo tipo C incluído. Apresentação em caixa de design ecológico.

7,5 x 14,5 x 1,6 cm 1/20 40

E(4), L2, W





WIRELESS CHARGER

BAMBOO COLLECTION



BAMBOO

WIRELESS
CHARGER

3024 Core

Carregador sem fios em bambu natural integrado em bandeja organizadora. Compatível com modelos da tecnologia de carregamento sem fios. DC5V. Cabo branco incluído. Apresentação em caixa individual eco.

27 x 1,5 x 14,5 cm  1

 20

 E(1), L2, W



2 USB 3.0 PORTS



BAMBOO

WIRELESS
CHARGER

USB



TYPE C



3001 Nebula

Carregador sem fio com corpo de bambú natural. Capacidade de carga de até 3 dispositivos simultaneamente. Compatível com modelos de tecnologia com carregamento sem fio. DC5V. Saída corrente USB DC5V/2,1A. Apresentação em caixa de design eco.

9 x 1 x 9 cm

 1/25

 50

 E(4),L2,W



BAMBOO



WIRELESS CHARGER

3022 Gravity

Carregador sem fios com corpo de bambu natural. Coloque o seu smartphone sobre ele e deixe carregar. Compatível com modelos com tecnologia sem fios. DC5V. Cabo incluído. Apresentação em caixa individual eco.

7 x 11,5 x 8 cm 1/25 50

E(4), L2

WIRELESS CHARGER



ECO DESIGN



BAMBOO



WIRELESS CHARGER



3027 Gamma

Carregador sem fios com suporte para telemóveis e comprimidos feitos de bambu natural. DC5V. 1m de cabo incluído. Apresentação em caixa de design ecológico.

12,5 x 8 x 1,6 cm 1/50 100

E(4), L2, W

WIRELESS CHARGER





BAMBOO



3055 **Antix**

Suporte para dispositivos móveis, tablet ou smartphone, feitos de bambu natural.

 6 x 2 x 8 cm

 1/50

 200

 D(4), L1, W

BAMBOO HOLDERS



BAMBOO

3010 **Lyra**

Suporte de bambú natural para telemóveis. Sulco inferior para cabo de carga. Inclui 2 partes de fácil montagem.

 8 x 8,1 x 12 cm

 1/50

 100

 D(4), L2, W



NEW.



BAMBOO



RECYCLED PET



TYPE C

3194 **Takay**

Altifalante sem fio com estrutura principal em bambu e tecido PET. Saída 3W e bateria recarregável. Ligação tipo C. Cabo incluído. Apresentação em caixa de design ecológico.

5,3 x Ø6 cm

1/25

50

F(1), L2



BAMBOO



RECYCLED PET



TYPE C

3193 **Bemol**

Altifalante sem fio com estrutura principal em bambu e tecido PET. Saída 3W e bateria recarregável. Ligação tipo C. Cabo incluído. Apresentação em caixa de design ecológico.

9,5 x 9,5 x 5,2 cm

1/10

30

F(1), L2

NEW.



NEW BEMOL

**NEW.**

BAMBOO

RECYCLED
PETFAST
CHARGERWIRELESS
CHARGER

TYPE C

**2988 Sibon**

Carregador sem fio com estrutura principal em bambu e tecido PET, compatível com dispositivos de tecnologia sem fio. Saída 10W. Ligação tipo C. Cabo incluído. Apresentação em caixa de design ecológico.

0,8 x Ø9,80 cm 1/50 100

F(1), L2

RPET + BAMBOO

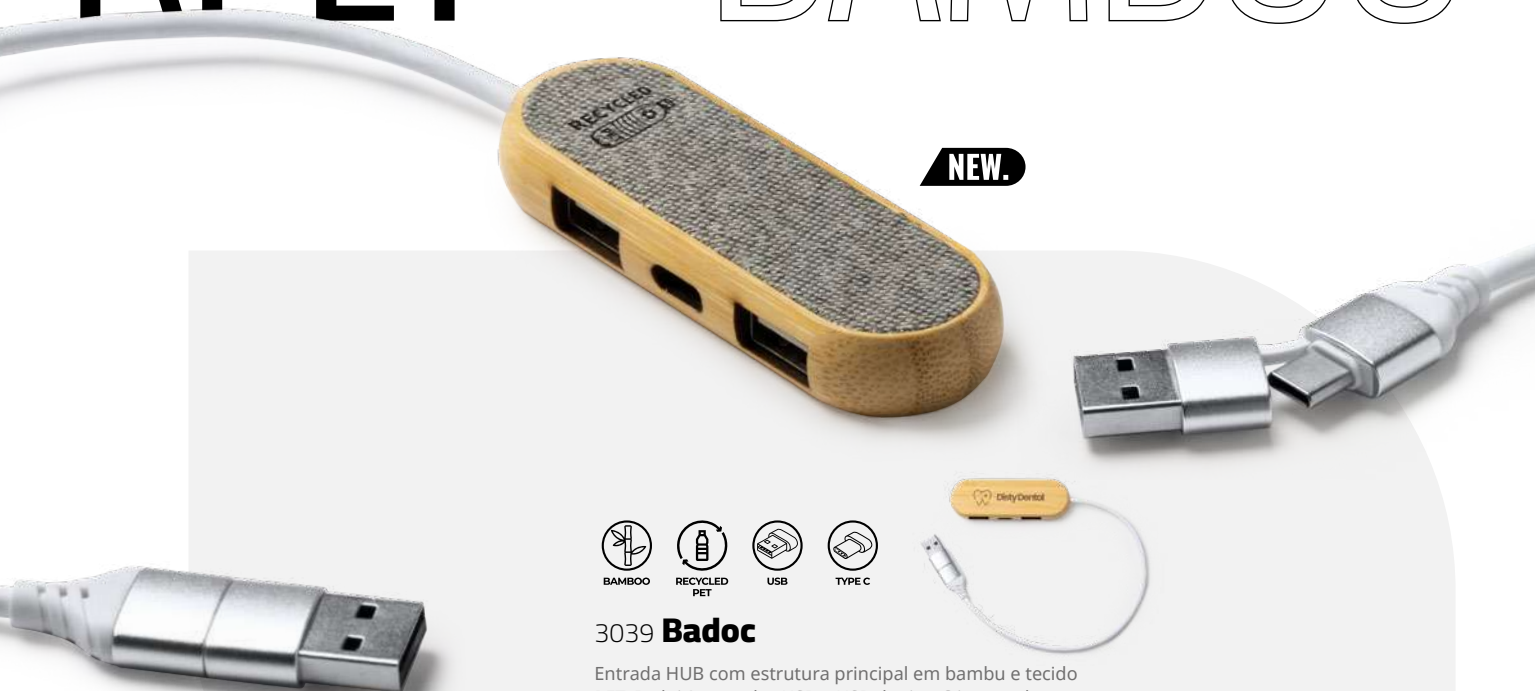
**NEW.**

BAMBOO

RECYCLED
PET

USB



TYPE C

3039 Badoc

Entrada HUB com estrutura principal em bambu e tecido PET. Inclui 2 entradas USB e USB do tipo C integradas. Apresentação em caixa de design ecológico.

8,2 x 1,2 x 2,6 cm 1/50 200

E(1), L2



CEMENT COLLECTION



3021 Mars

Carregador sem fios com corpo de bambu natural e base tipo pedra calcária. Coloque o seu smartphone sobre ele e deixe carregar. Compatível com modelos com tecnologia sem fios. DC5V. Cabo incluído. Apresentação em caixa individual eco.

9,4 x 12,5 x 9,4 cm

1/15 30

E(1), L2



3209 Heldens

Coluna de som sem fios Bluetooth com base de carregamento sem fios e membrana visível. Corpo tipo pedra calcária e superfície de bambu natural. Potência alta voz 5W e saída sem fios de DC5V. Bateria recarregável. Cabo incluído. Apresentação em caixa individual eco.

11,8 x 7,8 x 6,5 cm

1/10 20

F(4), L2



3208 Steve

Coluna de som sem fios com corpo tipo pedra calcária e superfície em bambu natural. Bluetooth 5.0. Potência 3W e bateria recarregável. Cabo incluído. Apresentação em caixa individual eco.

7,2 x Ø7 cm

1/15 30

E(4), L2



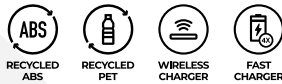

2999 **Zibal**

Carregador sem fios com corpo em ABS reciclado e superfície superior em tecido RPET. Coloque o seu smartphone sobre ele e deixe carregar. Compatível com modelos de tecnologia sem fios 10W. Inclui cabo micro USB. Apresentação em caixa ecológica.

Ø10 cm
E(1), W

1/50 100

RECYCLED ABS + RPET



3356 **Dilbar**

Bateria externa de 8.000 m Ah com corpo em ABS reciclado e superfície superior em tecido RPET. Saída de corrente USB DC5V/2.1A. Sem fios 10 W. Inclui cabo micro USB. Apresentação em caixa ecológica.

13,5 x 1,5 x 7,1 cm

1/20 40

F(1), N(8)





3311 **Elson**

Coluna sem fios com corpo em ABS reciclado. Bluetooth 5.0. Potência 3W. Bateria recarregável. Cabo incluído. Apresentação em caixa ecológica.

6,2 x Ø6,20 cm 1/25 50
E(1)



LED LIGHT

ELSON

VAIDI



TACTIL



3312 **Valdi**

Auriculares sem fios - Bluetooth 5.0 - com estojo próprio. Produzidos em ABS reciclado e superfície superior em bambu. Painel de controlo com tecnologia táctil integrado no auricular. Função mãos livres. Estojo com bateria recarregável e tampa magnetizada. Cabo micro USB incluído. Apresentação em caixa ecológica.

6,5 x 2,6 x 3,6 cm 1 50
E(4), L1, W

NEW DEMAR

NEW.



- RECYCLED PET
- WIRELESS CHARGER
- FAST CHARGER
- TYPE C



3038 Demar

Tapete para o rato em PET com carregador sem fio 10W embutido. Suportes móveis e para canetas incluídos. Apresentação em caixa de design ecológico.

31 x 0,8 x 27 cm 1/10 20
F(1), N(8)

RECYCLED
PETWIRELESS
CHARGER

BLUETOOTH

HANDS
FREE

TYPE C



3192 **Tenor**

Altifalante sem fio em tecido PET com estação de acoplamento sem fio de 5W. Saída 3W. Ligação tipo C. Cabo incluído. Apresentação em caixa de design ecológico.

8 x Ø9,30 cm

1/10

30

F(1)

NEW.



BLUETOOTH SPEAKER

RECYCLED
PET

BLUETOOTH

HANDS
FREE

3310 **Custik**

Coluna sem fios com corpo em tecido RPET e parte do invólucro em ABS reciclado com membrana visível. Bluetooth 5.0. Potência 3W. Bateria recarregável. Cabo incluído. Apresentação em caixa eco.

4,6 x Ø7,90 cm

1/25

50

F(4)



TACTILE

- WHEAT FIBER
- BAMBOO
- BLUETOOTH
- HANDS FREE
- TACTILE
- TYPE C

3041 Kuasi

Auriculares sem fio em fibra de trigo e bambu, com estojo de carregamento. Painel de controlo embutido com tecnologia de toque. Função "mãos livres". Bateria recarregável. Cabo tipo C incluído. Apresentação em caixa de design ecológico.

3,9 x 2,3 x 3,7 cm 1/50 100

E(4), W



CHARGING CASE

- WHEAT FIBER
- BLUETOOTH
- HANDS FREE
- TACTILE

3309 Burak

Auriculares sem fios - Bluetooth 5.0 - produzidos em fibra de trigo e com estojo próprio. Painel de controlo com tecnologia táctil, integrado no auricular. Função mãos livres. Estojo com bateria recarregável e tampa magnetizada. Cabo incluído. Apresentação em caixa ecológica.

6,8 x 2,2 x 4,5 cm 1/50 100

E(4), W

FAST CHARGER



- WHEAT FIBER
- BAMBOO
- BLUETOOTH
- HANDS FREE
- WIRELESS CHARGER
- FAST CHARGER

3308 Zatox

Coluna Bluetooth com base de carregamento sem fios. Corpo em fibra de trigo e superfície em bambu natural. 10W de potência de som e saída de carregamento sem fios de DC5V. Bateria recarregável. Apresentação em caixa de fabrico ecológico.

16 x 6 x 7,8 cm 1/15 30

F(4), L2

NORBY

WHEAT FIBER | FOLDABLE | HANDS FREE

HEADPHONES



WHEAT
FIBER



BLUETOOTH



RADIO FM



HANDS
FREE



MICRO SD



LINE IN

3035 **Norby**

Auscultadores sem fio em fibra de trigo. Almofadas inferiores e superior em pele sintética. Painel de controlo integrado com tecnologia stereo. Função mãos-livres e rádio FM. Bateria recarregável. Cabo incluído. Apresentação em caixa de design ecológico.

17 x 7,5 x 18,5 cm 1/10 20

F(1)



3198 **Kumber**

Altifalante sem fio de fibra de trigo. Rádio FM, entrada para cartão Micro SD e função mãos-livres. Saída 3W. Cabo incluído. Apresentação em caixa de design ecológico.

5 x Ø6 cm 1/25 50
E(4)



2996 **Vatox**

Base de carregamento sem fio de fibra de trigo. Compatível com dispositivos de tecnologia sem fios. 5W. Cabo Micro USB incluído. Apresentação em caixa de design ecológico.

1 x Ø7 cm 1/50 100
E(4), W



3057 **Bawen**

Suporte móvel dobrável em fibra de trigo com bordas antiderrapantes.

8,8 x 8,8 x 3 cm 1/100 500
B(4), W



WHEAT FIBER LINE

PLASTICS REDUCTION



3034 Gospek

Entrada HUB de fibra de trigo com 4 entradas USB integradas. Apresentação em caixa de design ecológico.

1,8 x Ø5,20 cm 1/50 200

D(4), W



2995 Melbux

Porta-lápis multifunções de fibra de trigo com suporte para smartphone, carregador DC5V e três entradas USB integradas. Cabo Micro USB incluído. Apresentação em caixa de design ecológico.

8,5 x 9 x 10 cm 1/25 50

E(1), W





UMEK

10W | PREMIUM FABRIC | LED LIGHTS



BLUETOOTH



HANDS FREE



TYPE C



CHANGING COLOR LIGHT



LINE IN

3196 **Umek**

Altifalante de design sem fio com acabamento em tecido especial. Membrana transparente com 6 modos de iluminação LED. Saída 10W. Inclui alça de transporte resistente e placa para impressão a laser. Bateria recarregável de longa duração. Cabo incluído. Apresentação em caixa de design ecológico.

18,5 x Ø7,50 cm 1/10 20

F(1), L2



BLUETOOTH



HANDS FREE



WIRELESS CHARGER



WATER RESIST



LINE IN



TYPE C

3191 **Sakura**

Alto-falante/banco de energia com função de carga sem fios de 5W. 10W de potência. Altifalante IPX7 à prova de água. Ligaçãõ tipo C. Cabo incluído. Apresentação em caixa de design.

19,9 x 8,5 x 9,1 cm

1/5

10

F(1), W



LED LIGHT



3203 **Vandik**

Coluna sem fios Bluetooth 5.0 com acabamento branco em toque de borracha. Combinação de tecido e cor. Painel de controlo tátil e luz LED multicolorida na base ao ritmo da música. Função mãos-livres. Potência 3W. Bateria recarregável. Cabo incluído. Apresentação em caixa de design.

10,6 x Ø7,10 cm 1 50
E(1)



3204 **Armin**

Coluna sem fios Bluetooth bicolor. Corpo em acabamento mate com toque de borracha. Alça de transporte, botões e tecido a condizer. Potência 3W. Bateria recarregável. Cabo incluído. Apresentação em caixa de design.

11,1 x 8,3 x 4,1 cm 1/1 50
E(1)





SUCTION CUP



3202 **Calvin**

Coluna sem fios com corpo ABS resistente a salpicos. Fixação através de ventosa. Função mãos-livres. Potência 3W. Bateria recarregável através de cabo Micro USB. Cabo incluído. Apresentação em caixa de design.

5,5 x Ø8,50 cm 1 50
F(1)



3200 **Cox**

Coluna sem fios em ABS com acabamento de toque suave. Bluetooth 3.0. Potência 3W. Função mãos-livres. Bateria recarregável. Cabo incluído. Apresentação em caixa de design.

7,5 x Ø6 cm 1 50
F(1)



MICRO SD



3201 **Garrix**

Coluna sem fios com corpo metálico e acabamento fosco. Bluetooth 3.0. Função rádio FM e mãos-livres. Potência 3W. Bateria recarregável. Cabo incluído. Apresentação em caixa de design.

5 x Ø5,90 cm 1/25 50
E(4), L1





WIRELESS EARPHONES
BLUETOOTH | FOLDABLE



RADIO FM



MICRO SD



BLUETOOTH



HANDS FREE



LINE IN

3150 **Legrand**

Auriculares sem fios Bluetooth 5.0 com acabamento em toque de borracha. Dobráveis. Acolchoado superior e almofadas em pele sintética macia. Laterais em alumínio ideais para marcação laser. Painel de controlo integrado com tecnologia stereo. Função mãos-livres e rádio FM. Bateria recarregável. Cabo incluído. Apresentação em caixa com faixa de design.

19 x 18,5 x 7,7 cm 1/10 20

F(1), L2

LEGRAND



60



05



02



01



RADIO FM



MICRO SD



BLUETOOTH



HANDS FREE



LINE IN

3151 **Rayel**

Auriculares sem fios Bluetooth 5.0 com painel de controlo integrado e tecnologia stereo. Dobráveis. Almofadas confortáveis em pele sintética. Função mãos-livres e rádio FM. Bateria recarregável. Cabo incluído. Apresentação em caixa de design.

19 x 17,5 x 8 cm 1/10 20

F(1)

FOLDABLE



NEW TACET

NOISE CANCELLING | BLUETOOTH



NEW.



BLUETOOTH



HANDS
FREE



TYPE C



TACTILE

3040 Tacet

Auriculares sem fio com cancelamento de ruído. Painel de controlo embutido com tecnologia de toque. Função "mãos livres". Caixa de carregamento com bateria recarregável e ligação tipo C. Cabo incluído. Apresentação em caixa de design.

5,9 x 5,3 x 2,9 cm 1/50  100

 E(4), W



NEW COSTEN



3037 Costen

Auriculares sem fio com estojo de carregamento. Painel de controle embutido com tecnologia de toque. Função "mãos livres". Bateria recarregável com ligação tipo C. Cabo incluído. Apresentação em caixa de design.

4,6 x 4,6 x 2,3 cm 1/50 100

E(4), W



FUNK



LCD DISPLAY



CHARGING CASE

3307 Funk

Auscultadores sem fios Bluetooth 5.0 com bolsa de carregamento. LED exibe o case. Botão multifuncional integrado em ambos os fones de ouvido. Função mãos-livres. Caixa com acabamento mate e bateria recarregável. Inclui cabo. Apresentação em caixa.

6,2 x 2,8 x 4 cm 1/50 100

E(4), W

WIRELESS CHARGING TECHNOLOGY



3025 Trap

Auriculares sem fio Bluetooth 5.0 com caixa de transporte. Botão multifunções integrado em ambos auriculares. Função mãos livres. Bateria recarregável mediante tecnologia sem fios. Cabo incluído. Apresentação em caixa individual.

7,5 x 3,2 x 3,2 cm 1/50 100

E(4), W



TACTILE



CHARGING CASE



3309 Burak

Auriculares sem fios – Bluetooth 5.0 - produzidos em fibra de trigo e com estojo próprio. Painel de controlo com tecnologia táctil, integrado no auricular. Função mãos livres. Estojo com bateria recarregável e tampa magnetizada. Cabo incluído. Apresentação em caixa ecológica.

6,8 x 2,2 x 4,5 cm 1/50 100

E(4), W

CHARGING CASE



TACTILE



3305 Ferry

Auriculares sem fios Bluetooth 5.0 com caixa de carregamento. Elegante acabamento branco brilhante. Painel de controlo com tecnologia tátil incorporada para auricular. Função mãos-livres. Caixa com bateria recarregável e tampa magnetizada. Cabo incluído. Apresentação em caixa de design.

6,8 x 2,2 x 4,5 cm 1/50 100

E(4), W

BLUETOOTH EARPHONES + CHARGING CASE



CHARGING CASE



TACTILE



3026 Blues

Auriculares sem fio Bluetooth 5.0 com caixa de transporte em bambu natural. Botão multifunções integrado em ambos auriculares. Função mãos livres. Bateria recarregável. Cabo incluído. Apresentação em caixa individual eco.

7,8 x 3,2 x 3,2 cm 1/50 100

E(4), L1, W



BLUETOOTH

HANDS FREE

STEREO SOUND



01



02



3302 **Kura**

Auscultadores sem fios com painel de controlo e microfone incorporado. Som stereo. Apresentado num prático estojo em pele sintética com fecho. Bateria recarregável. Cabo incluído.

3,9 x Ø8 cm

1/50

200

E(1), G(4)

EARPHONES



3301 **Punk**

Auriculares apresentados em invólucro prático em PVC transparente com fecho automático. Ligação com conectos de 3,5 mm. Cabo com botão de segurança incluído.

8 x 7,8 x 1,2 cm 1/50 500

E(1)

3300 **Aoki**

Auriculares em estojo em PS. Ligação com conectos de 3,5 mm. Cabo com botão de segurança incluído. Inclui 3 pares de invólucros de tamanhos diferentes.

7 x 7 x 2 cm

1/50

500

D(1), W

MULTI FUCTION SMART WATCHES



DRACO_3401

WILLMAN_3402

NORA_3405



- BLUETOOTH
- CALORIES COUNTER
- PEDOMETER
- SLEEP CONTROL
- MESSAGE NOTIFY
- HEART RATE MONITOR
- APP
- REMOTE CAMERA

- BLUETOOTH
- CALORIES COUNTER
- PEDOMETER
- SLEEP CONTROL
- MESSAGE NOTIFY
- HEART RATE MONITOR
- APP
- REMOTE CAMERA

- BLUETOOTH
- CALORIES COUNTER
- PEDOMETER
- SLEEP CONTROL
- HEART RATE MONITOR
- STOPWATCH
- APP
- BLOOD PRESSURE
- MUSIC PLAYER
- PHONE CALLS
- OXYGEN PRESSURE
- TACTILE

3401 Draco

Relógio inteligente com funções de atividade. Corpo em TPU e visor a cores TFT. Pulseira ajustável em silicone e fivela em metal. Monitorização da frequência cardíaca. Ligação Bluetooth com APP para iOS e Android. Cabo USB de carregamento incluído. Apresentação em caixa de design.

26 x 1,9 x 1,2 cm 1/50 100
I(1), L2

3402 Willman

Relógio inteligente com funções de atividade. Corpo em TPU e mostrador a cores TFT de 1,3" com USB de carregamento integrado. Pulseira ajustável em silicone e fivela em metal. Monitorização da frequência cardíaca. Ligação Bluetooth com APP para iOS e Android. Apresentação em caixa de design.

25 x 1,1 x 3,4 cm 1 50
I(1), L2

3405 Nora

Relógio Inteligente com características de atividade. Correia TPU ajustável e visor de ecrã táctil IPS. Monitorização do ritmo cardíaco e controlo de chamadas. Ligação Bluetooth com APP para iOS e Android. Cabo de carregamento USB incluído. Apresentação em caixa de desenho.

27 x 1,2 x 3,9 cm 1 50
I(1), L2



MICRO SD WATERPROOF APP 4K ULTRA HD WI-FI

2100 **Discovery**

Câmara desportiva com tecnologia de vídeo HD 4K e ligação Wi-Fi. Ecrã LCD de 2". Com função de câmara fotográfica Full HD 1080P. Inclui invólucro submersível até 30m e diversos acessórios de encaixe multifunções. Bateria recarregável removível. Cabo incluído. Apresentação em caixa de design.

6 x 4,2 x 3 cm 1 20
K(4)



4K CAMERA
DISCOVERY

DROIDE



01 03 60 05 02 226 0

PRINTINGZONE



3354 **Droide**

Bateria solar externa de 4000 mAh. Indicador de carga LED e luz. Saída de corrente DC5V/2.1A. Inculi cabo Micro USB. Apresentação em caixa design.

7,5 x 14,5 x 1,5 cm 1/20 40
E(2)

CARABINER INCLUDED





SPECIAL FOR DIGITAL PRINTING

10000 mAh



0101

6001

0501

22601

3352 Robbie

Bateria externa em ABS bicolor com 10000mAh. Indicador de carregamento LED. Saída de corrente DC5V/2,1A. Inclui cabo Micro USB. Apresentação em caixa de design.

14,4 x 1,4 x 7,7 cm

1/10

40

E(4), W



2600 mAh



01

60

05

251

02

3350 Bender

Bateria externa em alumínio com capacidade de 2600 mAh. Indicador de carregamento LED. Inclui cabo de ligação USB e Micro USB. Apresentação em caixa de design.

9,4 x 2,1 x 2,2 cm

1/25

100

D(4), L1, W

EXTERNAL BATTERY



SUCTION CUPS



SPECIAL FOR DIGITAL PRINTING



WIRELESS CHARGER



USB

5000 mAh

3353 Hal

Bateria externa em ABS para carregamento sem fios com 5000mAh. Função de fixação através de ventosa. Indicador de carregamento LED. Saída de corrente USB DC5V/2,1A. Sem fios DC5V/1A. Inclui cabo Micro USB. Apresentação em caixa de design.

10,4 x 6,5 x 1,6 cm

1/25

50

F(4), W



BAMBOO



USB

5000 mAh

3355 Rossum

Bateria externa de 5.000 mAh, com corpo em ABS branco e superfície superior em bambu. Saída de corrente USB DC5V / 2.1A. Inclui cabo Micro USB. Caixa em papel kraft

10,1 x 1,5 x 6,3 cm

1/25

50

E(4), L2, W



60

05

02

3003 Lander

Base de carregamento sem fios para smartphone. Ligue o dispositivo, coloque o seu smartphone no mesmo e deixe-o carregar. Compatível com modelos de tecnologia de carregamento sem fios. 10 W. Cabo incluído. Apresentação em caixa de design.

1 x Ø7 cm

1/50

200

E(4), W



WIRELESS CHARGER

WHEAT FIBER

2996 Vatox

Base de carregamento sem fio de fibra de trigo. Compatível com dispositivos de tecnologia sem fios. 5W. Cabo Micro USB incluído. Apresentação em caixa de design ecológico.

1 x Ø7 cm

1/50

100

E(4), W



WIRELESS CHARGER

FAST CHARGER

BAMBOO

3018 Soyuz

Carregador sem fio com corpo em ABS branco e superfície superior de bambu natural. Coloque o seu smartphone sobre ele e deixe-o carregar. Compatível com modelos com tecnologia wireless. DC5V. Inclui cabo. Caixa em papel kraft.

1 x Ø6 cm

1/50

200

E(4), L2, W



ALUMINIUM



WIRELESS CHARGER

FAST CHARGER

BAMBOO



999

01

02

3005 Falcon

Carregador sem fios com corpo em alumínio. Ligue o dispositivo, coloque o seu smartphone no mesmo e deixe-o carregar. Uma luz indicará que está a carregar. Compatível com modelos de tecnologia de carregamento sem fios. DC5V/1,0A. Cabo incluído. Apresentação em caixa de design.

7 x Ø9,80 cm

1/50

100

E(1), L1, W



3033 Plerion



Multi porta USB em alumínio, acabamento bicolor e cabo branco. Inclui 4 portas USB. Apresentação em caixa branca.

8,9 x 3,7 x 2,1 cm 1/50 200

D(4), L1



3023 Neptune

Porta USB com corpo de bambu natural e cabo em branco. Inclui 3 portas USB. Apresentação em caixa individual eco.

8,5 x 1,6 x 4 cm 1/50 200

D(4), L1, W



NEW.



3039 Badoc

Entrada HUB com estrutura principal em bambu e tecido PET. Inclui 2 entradas USB e USB do tipo C integradas. Apresentação em caixa de design ecológico.

8,2 x 1,2 x 2,6 cm 1/50 200

E(1), L2



3019 Astro

Cabo carregador 3 em 1. ABS e corpo de bambu natural. Micro USB, tipo C e conexão Lightning. Apresentação em saco ecológico com janela.

16,5 x 1 x 2,1 cm 1/100 400

D(1), L1





2 ACCESSORIES

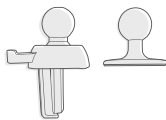

3054 Hydra

Suporte para smartphone com carregador sem fios para veículo. Ligue o dispositivo, coloque o telemóvel no mesmo e deixe-o carregar. Compatível com modelos de tecnologia de carregamento sem fios. Cabo e dois acessórios incluídos. Carregamento rápido 10W. DC5V/1,0A. Apresentação em caixa de design.

8,5 x 10 x 9,4 cm 1 50

E(1)



60

05

02

01



3000 Tardis

Conjunto de carregadores USB para automóvel e de parede. Apresentado num estojo em PU com fecho. Velocidade de carregamento de 1000 mAh.

8 x 4,2 x 6,3 cm 1/50 200

C(4), E(1)



01

02

3013 Bopp

Adaptador de viagem universal compacto e retrátil. Luz led. Acabamento mate e toque suave. Europa, Ásia, Reino Unido, EUA, Austrália. 2 saídas USB. Velocidade de carregamento de 2100 mAh. Apresentação em caixa branca.

6,1 x 5,6 x 4,5 cm 1/50 100

D(1), W



60

60

05

02

3014 Gordon

Adaptador universal de viagem. Europa, Ásia, Reino Unido, EUA, Austrália. Apresentação em caixa branca.

8,2 x Ø4,50 cm 1/50 100

D(4)



3010 **Lyra**

Suporte de bambú natural para telemóveis. Sulco inferior para cabo de carga. Inclui 2 partes de fácil montagem.

8 x 8,1 x 12 cm 1/50 100

D(4), L2, W



3055 **Antix**

Suporte para dispositivos móveis, tablet ou smartphone, feitos de bambu natural.

6 x 2 x 8 cm 1/50 200

D(4), L1, W



01 60 05 226 02

3056 **Kunir**

Suporte móvel dobrável com bordas antiderrapantes.

8,8 x 8,8 x 3 cm 1/100 500

B(4), W



3057 **Bawen**

Suporte móvel dobrável em fibra de trigo com bordas antiderrapantes.

8,8 x 8,8 x 3 cm 1/100 500

B(4), W

SUBLIMATION



2998 **Sonic**

Tapete de rato XL. Superfície macia de poliéster, especial para sublimação, e base antiderrapante. Apresentação individual.

70 x 35 cm

1/10

30

F(1), R



MOUSEPADS

SUBLIMATION



01



60



05



02

2997 **Yuba**

Tapete de rato redondo. Superfície macia de poliéster e base antiderrapante.

Ø20 cm

1/100

200

E(1), N(8), R



SONIC MOUSE PAD

EXTRA LARGE | SPECIAL FOR SUBLIMATION

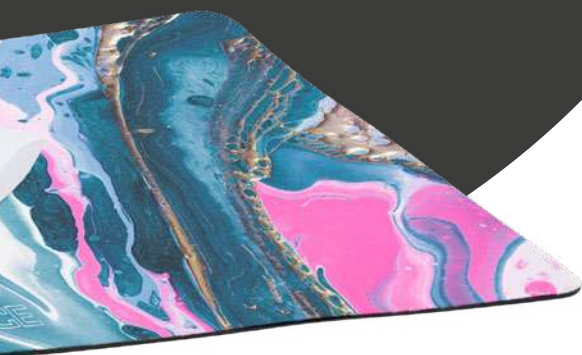

SUBLIMATION



01

03

60

05

226

02

3011 Sira

Tapete de rato com design plano. Superfície em poliéster macio e base em silicone antiderrapante.

22 x 18 cm

1/100

200

E(1), N(8), R



01

60

05

02

3012 Silvano

Tapete de rato em poliéster suave com apoio de pulso acolchoado. Base antiderrapante em silicone.

20,5 x 24,3 x 2 cm

1

100

E(1), N(8), R



PADDED

NEW REMY

BAMBOO | RECYCLED ABS



NEW.



3049 **Remy**

Rato sem fio em bambu e ABS reciclado com sensor de precisão ótica. 2 pilhas AA não incluídas. Apresentação em caixa de design ecológico.

 10,2 x 3,4 x 5,8 cm  1/50  200

 E (1), W



3050 **Kasper**

Tampa para câmara de dispositivo ou webcam. Com autocolante reutilizável 3M e mecanismo deslizante.

3,2 x 1,3 x 0,1 cm 100 10000
B(1), W



3052 **Jerry**

Rato dobrável sem fios com um sensor óptico de precisão. Design ergonómico com superfície em toque de borracha. 2 pilhas AAA não incluídas Apresentação em caixa branca.

10,8 x 3,6 x 6 cm 1/50 100
E(1), W



FOLDABLE



3051 **Stuart**

Rato sem fios com sensor óptico de precisão e botão DPI integrado. Superfície com acabamento em toque de borracha. 2 pilhas AAA não incluídas Apresentação em caixa branca.

11,2 x 2,4 x 5,7 cm 1/100 200
E(4), W

USB STOCK



4189 Percy

Pen drive USB com corpo e clipe giratório em bambu natural. Apresentação em caixa ecológica.

6,3 x 3,2 x 1,3 cm 1/50 300

D(4), L1



4190 Uldon

Pen drive USB com corpo em bambu natural e clipe giratório em metal. Apresentação em caixa ecológica.

5,7 x 2 x 1,2 cm 1/50 300

D(4), L1



4196 Vibo

Cartão de memória USB em cartão reciclado com clipe giratório de metal. Apresentação em caixa de design ecológico.

5,8 x 2 x 1 cm 1/50 500

D(4), L1



4194 Venak

Cartão de memória USB em fibra de trigo com clipe giratório de metal. Apresentação em caixa de design ecológico.

5,7 x 1,9 x 0,9 cm 1/50 500

D(4), L1



4193 Kinnox

Cartão de memória USB com estrutura principal e clipe giratório em fibra de trigo. Apresentação em caixa de design ecológico.

5,9 x 1,7 x 0,9 cm 1/50 500

D(4), W

USBSTOCK



NEW.



16 GB



4191 Gudar

Cartão de memória USB com estrutura principal em bambu. Apresentação em caixa de design ecológico.

6,4 x 2,2 x 1,3 cm 1/50 500

D(4), L1, W



NEW.



16 GB



4198 Netix

Cartão de memória USB com estrutura principal em bambu. Apresentação em caixa de design ecológico.

5,8 x 1,4 x 0,6 cm 1/50 500

D(4), L1, W



NEW.



16 GB



4197 Ledes

Cartão de memória USB em cartão reciclado com caixa em cortiça natural. Apresentação em caixa de design ecológico.

7 x 2,9 x 0,5 cm 1/50 500

D(4), L1, W



NEW.

16 GB



4195 Viken

Cartão de memória USB cilíndrico em cartão reciclado. Apresentação em caixa de design ecológico.

6,7 x Ø1,8 cm 1/50 500

D(4), W

USBSTOCK

NEW.



16CB

4192 Riot

Cartão de memória USB com estrutura principal em ABS e clipe giratório correspondente. Apresentação em caixa com janela.

5,7 x 0,9 x 1,9 cm 1/50 500

D(4), L1

16CB

32CB



4188 Roy

Pen drive USB de metal ultracompacto. Apresentação em caixa de cartão branco mate.

3,8 x 0,4 x 1,2 cm 1/100 1000

D(4), L1

USB FLASH DRIVES

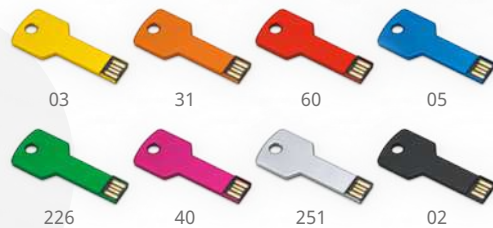

16CB

32CB



4186 Marvin

Pen drive USB de design clássico com corpo em ABS e clipe giratório de metal. Apresentado em caixa de cartão branco mate.

5,7 x 0,9 x 1,9 cm 1/50 300

D(4), L1

16CB



4187 Cylon

Pen drive USB de alumínio com design extra plano em forma de chave. Apresentação em caixa de metal com janela.

5,7 x 0,3 x 2,4 cm 1 200

D(4), L1

USB 2023

MADE TO ORDER



REQUEST OUR WEEKLY RATE

Models with up to 64Gb of capacity. OTG models, 3.0 connection. Custom 2D and 3D designs.
Quotes in 24-48h.



Free standard presentation box



File recording service



Free special pantone color from
500 units *
(*Check available models)



WRITING & OFFICE

FE



7993 **Reydon** 

Conjunto elegante de caneta esferográfica e lapiseira, com design em aço escuro. Apresentação em estojo em pele acolchoado e revestimento interior. Tinta azul.

 13,6 x Ø1,10 cm  1/25  50

 C(1), D(4), L1

WRITING







NATURAL CORK



7991 **Alton** 

Caneta esferográfica rotativa com corpo em cortiça natural e aço. Detalhes platinados e cromados. Tinta azul. Apresentação em caixa de design ecológico.

 13,6 x Ø1,10 cm  1/50  300

 B(4), L1



CORK PENS



NATURAL CORK

8044 **Artur** 

Caneta metálica elegante com acabamento cromado e cabo de cortiça. Carga jumbo metálica com tinta azul

 13,9 x Ø1,10 cm  1  200

 D(1), L1



NATURAL CORK

7992 **Suver** 

Caneta roller em cortiça natural e aço. Apresentação em estojo elegante com detalhe em cortiça e revestimento interior acolchoado. Tinta azul.

 13,8 x Ø1,10 cm  1/50  100

 C(1), D(4), L1



BAMBOO



8041 **Bodoni**

Caneta esferográfica rotativa de bambu com detalhes em aço inoxidável. Apresentação em estojo de bambu com fecho magnético. Tinta azul.

17,5 x 2,5 x 5,7 cm

1/25 100

D(4), L2



BAMBOO PENS



BAMBOO

8036 **Kioto**

Conjunto de caneta e lapiseira em bambu. Mecanismo de botão de pressão. Tinta azul. Apresentado em caixa de cartão com efeito de madeira.

17 x 2,2 x 4,1 cm 20

200

C(4), D(4), L1

8093 **Besky**

Caneta esferográfica com corpo em bambu e botão de pressão com acabamento em metal. Grande recarga de tinta azul.

14 x Ø1,10 cm

1/50

1000

B(4)



8018 **Tucuma**

8019 **Pampa**

7986 **Davos**

NEW.

BAMBOO LINE



BAMBOO

8018 **Tucuma** 

Caneta esferográfica de bambu natural com acessórios de design em acabamento prateado. Tinta azul.

 13,9 x Ø1,10 cm  1/50  1000
 B(4), L1



BAMBOO



TOUCH PEN

8019 **Pampa** 

Caneta de bambu natural com clipe metálico e ponteiro de toque. Carga jumbo com tinta azul.

 14,8 x Ø1 cm  1/50  1000
 B(4), L1



BAMBOO

7986 **Davos** 

Caneta esferográfica de bambu com botão de pressão e detalhes em metal. Tinta azul.

 13,8 x Ø1,10 cm  1/50  1000
 B(4), L1

8034 **Stoa**

8080 **Gildon**

8084 **Nagoya**



2929 0329 3129 6029 24229 11429



8034 **Stoa**

Caneta com botão com corpo em bambu e acessórios de fibra de trigo/ABS. Tinta azul.

14,1 x Ø1 cm 1/50 1000
 B(4), L1

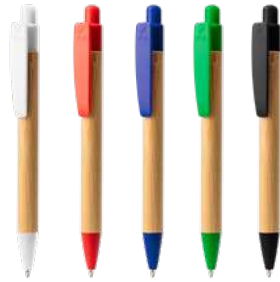

01 60 05 226 02



8080 **Gildon**

Caneta de bambu reciclado e cano PLA. Tinta azul.

14 x Ø1 cm 50 1000
 B(4), L1



29 03 60 114 242 02



8084 **Nagoya**

Caneta de botão de pressão com corpo de bambu, acessórios de fibra de bambu e clipe metálico. Inclui estilete. Tinta azul.

14 x Ø1,50 cm 1/50 1000
 B(4), L1

NEW.



BAMBOO

7982 **Penta** 

Caneta esferográfica com acabamento fosco, detalhe antiderrapante em bambu e detalhes em cores escuras. Tinta azul.

 14,3 x Ø1 cm  1/50  1000

 B(4), L1



01 31 49 71 242 226 02

NEW PENS

NEW.



BAMBOO

7990 **Olten** 

Caneta esferográfica com acabamento fosco, detalhe antiderrapante em bambu e ponta para ecrã tátil. Tinta azul.

 14,5 x Ø1 cm  1/50  500

 B(4), L1



01 55 47 02

NEW ROLLER PIRGO



NEW.



BAMBOO

7983 **Pirgo**

Caneta rotativa com corpo de bambu e detalhes em metal. Grande recarga de tinta azul.

 13,8 x Ø1,10 cm  1/50  1000

 B(4),L1



01 03 60 05 226 02



01 03 60 05 02



8017 **Coloma**

Caneta rollerball com corpo em ABS de toque suave. Clipe e ponta de metal. Carga jumbo com tinta azul.

 14,3 x Ø1,10 cm  1/50  1000

 A(4)

8021 **Yama**

Esfereográfica tipo roller com clipe metálico e detalhes em acabamento prata. Carga jumbo de tinta azul.

 13,5 x Ø1,10 cm  1/50  1000

 A(4)



8076 **Conwi**

8009 **Merlin**

8031 **Sagano**

8025 **Lika**

8028 **Gorbea**



251 29



8025 **Lika**

Caneta com botão em fibra de trigo e ABS com acabamentos em cor preta. Tinta azul.

14 x Ø1,30 cm 1/50 1000

A(4)



8031 **Sagano**

Caneta com botão feita de bambu. Carga Jumbo de tinta azul.

14 x Ø1,30 cm 1/50 1000

A(4), L1



8028 **Gorbea**

Caneta com botão em fibra de trigo e ABS. Tinta azul.

14 x Ø1,30 cm 1/50 1000

A(4)



01 03 31 60 40 05 242 114 226 02



01 03 31 60 40 05 226 02

8009 **Merlin**

Caneta em ABS com botão e pega suave. Tinta azul.

14 x Ø1,30 cm 1/50 1000

A(4)

8076 **Conwi**

Caneta ABS com botão de pressão numa variedade de cores. Disponível em tinta azul e preta.

14 x Ø1,30 cm 1/50 1000

A(4)

+ antibacterial
ISO 22196



01



03 31 60 05 226 02



01 60 05 02



antibacterial
ISO 22196

8038 Newton

Caneta esferográfica com corpo em ABS antibacteriano. Tinta azul. Padrão ISO 22196: 2011.

14 x Ø1,30 cm 1/50 1000

A(4)



antibacterial
ISO 22196

8039 Carrel

Caneta esferográfica com corpo em ABS antibacteriano e pega translúcida e macia. Tinta azul. Padrão ISO 22196: 2011.

14 x Ø1,30 cm 1/50 1000

A(4)



antibacterial
ISO 22196



TOUCH PEN

8022 Farber

Esferográfica higienizante anti bacteriana multifunções, com pulverizador recarregável e ponteiro tátil. Capacidade 3 ml (líquido não incluído). Tinta azul

16 x Ø1,50 cm 1/50 1000

B(4)



8040 Stark

8045 Hindres

8010 Stix

8035 Kamut



03 31 60 05 114 226 40 02

8045 Hindres

Esferográfica de ABS com botão de pressão. Corpo em cor branca e clip em várias gamas de cores. Tinta azul

13,8 x Ø1 cm 1/50 1000
A(4)

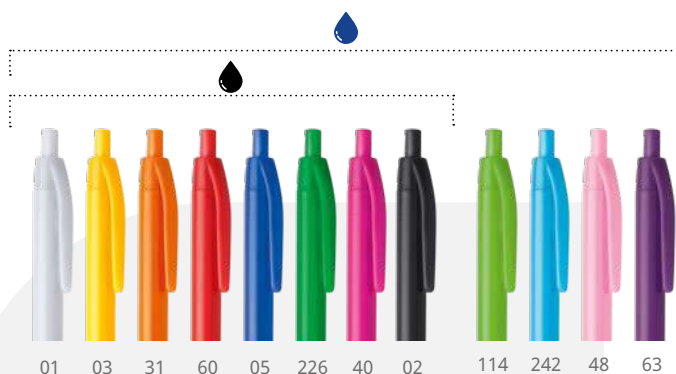

01 03 31 60 05 226 40 02 114 242 48 63

8010 Stix

Caneta ABS com botão de pressão numa variedade de cores. Disponível em tinta azul e preta.

13,8 x Ø1 cm 1/50 1000
A(4)

+ antibacterial
ISO 22196

+ anti bacterial
ISO 22196

8040 Stark

Caneta esferográfica com corpo em ABS. Antibacteriana. Tinta azul. Padrão ISO 22196.

13,8 x Ø1 cm 1/50 1000
A(4)



29 03 31 60 242 114

8035 Kamut

Caneta com botão realizada em fibra de trigo e ABS. Tinta azul.

13,8 x Ø1 cm 50 1000
A(4)



8096 **Dante** 

Caneta esferográfica com botão de pressão. Corpo em diversas cores e confortável de segurar. Detalhes a preto e metal. Tinta azul.

 13,8 x Ø1 cm  1/50  1000

 A(4)



8099 **Citix** 

Caneta esferográfica com botão de pressão condizente e ponta com acabamento em duas cores. Tinta azul.

 14 x Ø1,10 cm  1/50  1000

 A(4)

CITIX & DANTE

SAME DESIGN ANOTHER CONSCIENCE



WHEATFIBRE



8032 Hana



8008 Ontario

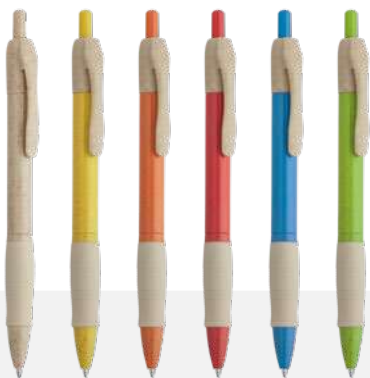

29 03 31 60 242 114





01 03 31 60 40 05 242 226 02



WHEAT FIBER

8032 Hana

Caneta com botão em fibra de trigo e ABS com pega cômoda. Tinta azul.

 14,5 x Ø1 cm  1/50  1000

 A(4)

8008 Ontario

Caneta com botão em acabamento translúcido e pega confortável. Tinta azul.

 14,5 x Ø1 cm  1/50  1000

 A(4)

100% ECOFRIENDLY



8029 Grove

Caneta com botão feita em cartão reciclado. Com ponta e clipe em fibra de trigo e ABS. Tinta azul.

14 x Ø1 cm

50

1000

A(4), W

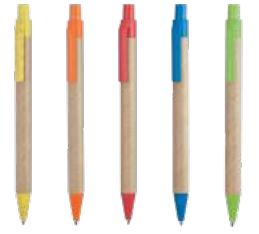

03 31 60 242 114



29 6029 24229 0229



8079 Alder

Caneta de papelão reciclado e cano PLA. Tinta azul.

13,9 x Ø0,90 cm

50

1000

A(4), W



01 60 05 226 02



8043 Comper

Caneta de linha ecológica com detalhes de cano de cortiça e fibra de trigo. Tinta azul.

14 x Ø1 cm

1/50

1000

A(4)



29 60 242 114 02



8042 Liande

Caneta em cartão reciclado com tampa. Tinta azul.

14,2 x Ø0,80 cm

50

1000

A(4), W



01 03 60 05 226 29

100% RPET

MADE FROM RECYCLED PLASTICS

8048 **Arashi**



03 31 49



8048 **Arashi**

Caneta marcadora 2 em 1 com design translúcido fabricado a partir de material RPET. Esferográfica de tinta azul. Marcador em cores fluorescentes.

 14,6 x Ø1,30 cm  1/50  1000

 A(4)

8033 **Pacific**



00 31 60 242 05 226 02

8033 **Pacific**

Caneta de design translúcido feita a partir de material RPET. Mecanismo de botão de pressão. Tinta azul.

 14,2 x Ø1,10 cm  50/50  1000

 A(4)

STYLE & COLOUR



60 05 251 02

8012 **Dormitur**

Caneta rotativa em ABS com acabamento metalizado. Tinta azul.

 15 x Ø1,10 cm  1/50  1000

 A(4)



8012 **Dormitur**

8011 **Irati**

8006 **Semenic**



0201 0203 0231 0260 0205 02226

8011 **Irati**

Caneta rotativa em ABS com acabamento brilhante bicolor. Tinta azul.

 14,5 x Ø1 cm  1/50  1000

 A(4)



31 60 05 226 251 02

8006 **Semenic**

Caneta rotativa em ABS com ponteira táctil. Acabamento metalizado. Tinta azul.

 13,5 x Ø1 cm  1/50  1000

 A(4)



TOUCH PEN

4 COLOURS

3 COLOURS

MULTI COLOUR PENS



60 05 226 02



60 05 251

8094 **Kunoy**

Caneta esferográfica retrátil de 4 cores. Corpo em ABS e revestimento suave para segurar. Tintas azul, preta, vermelha e verde.

14,1 x Ø1,30 cm 1/50 1000

A(4)

8098 **Sandur**

Caneta esferográfica retrátil de três cores. Corpo em ABS com detalhes a preto e revestimento suave. Tintas azul, preta e vermelha.

14,8 x Ø1,10 cm 1/50 500

A(4)

SPECIALFORLASER







SPECIAL LASER
ENGRAVING



01 60 05 55 226 02

8095 **Dover** 

Caneta esferográfica com botão de pressão com corpo em metal suave ao toque. Ponta, clip e botão de pressão em acabamento cromado e platinado. Tinta azul. Especial para impressão a laser.

 13,7 x Ø1 cm  1/50  500
 B(4), L1



8014 **Borneo**

8004 **Canaima**

8005 **Baume**



01 03 60 05 226 02

8014 **Borneo** 



TOUCH PEN

Caneta metálica com botão. Ponteira tátil e clipe de design. Carga Jumbo de tinta azul.

 14,8 x Ø1 cm  50  500
 B(4), L1







01 03 31 60 40 05 226 02

8004 **Canaima** 



TOUCH PEN

Caneta rotativa em alumínio com ponteira tátil. Tinta azul.

 12,5 x Ø0,90 cm  1/100  1000
 B(4), L1







01 03 31 60 05 226 251 02

8005 **Baume** 



TOUCH PEN

Caneta rotativa em alumínio com ponteira tátil na cor do corpo. Tinta azul.

 13,7 x Ø0,70 cm  1/100  1000
 B(4), L1



29



BAMBOO

8093 **Besky**

Caneta esferográfica com corpo em bambu e botão de pressão com acabamento em metal. Grande recarga de tinta azul.

 14 x Ø1,10 cm  1/50  1000

 B(4)



29 03 31 60 242 114



WHEAT FIBER

8030 **Hayedo**

Caneta com botão em fibra de trigo e ABS com acabamento prateado. Tinta azul.

 14,1 x Ø1 cm  1/50  1000

 A(4)

SAME DESIGN | DIFFERENT FINISHING TOUCHES



01 60 05 226 251 02

8013 **Ardenes**

Caneta com corpo em alumínio e botão. Acabamento anodizado. Carga Jumbo de tinta azul.

 13,7 x Ø1 cm  1/50  500

 B(4), L1

SOFT TOUCH



01 03 60 05 226 02

8078 **Norfolk**

Caneta com cano metálico de toque suave e botão de acabamento anodizado. Ponta de metal cromado, clip e marcações. Recarga de tinta preta Jumbo.

 13,6 x Ø1 cm  1/50  500

 B(4), L1

METALLIC COLOURS



TOUCH PEN

8090 **Kruger**

Caneta com corpo em alumínio e botão com acabamento anodizado. Ponteiro táctil e carga Jumbo de tinta azul.

 13,9 x Ø1 cm  1/50  500

 B(4), L1

+ antibacterial
ISO 22196





antibacterial
ISO 22196



TOUCH PEN

8015 **Hallerbos**

Caneta com corpo em ABS antibacteriano e ponteiro tátil. Clipe em metal e carga jumbo com tinta azul. Padrão ISO 22196.

 13,9 x Ø1 cm  1/50  1000

 A(4)

RECYCLED ALUMINUM
NEW
ALVIK

NEW.







01 57 43 02



7973 **Alvik** 

Caneta esferográfica elegante com corpo em alumínio reciclado e detalhes em metal. Grande recarga de tinta azul.

 14,2 x Ø1,10 cm  1/50  500

 B(4), L1

NEW SIMON

RECYCLED ALUMINIUM

NEW.



01 60 05 226 251 46 02



7972 Simon

Caneta esferográfica com corpo em alumínio reciclado e botão de pressão com acabamento anodizado. Grande recarga de tinta azul.

14 x Ø1 cm 1/50 500
B(4), L1

NEW ALVOR



NEW.



55 47 02

7975 Alvor

Porta-caneta em imitação de camurça.

15,5 x 2,5 cm 10/200 6000
B(1)



01 29 02

7995 Burton

Embalagem em cartão para canetas com abertura frontal.

4 x 15,5 cm 50/400 4000
B(4)

PERPETUAL PENCIL

NEW

TURIN

NEW.



251 02

7976 Turin

Lápis com corpo de alumínio. Ponta em chumbo para escrita intercambiável. Não é preciso afiar. Apresentação em caixa ecológica.

 15 x Ø0,80 cm  1/50  500

 B(4), L1



NEW.



WHEAT FIBER



RECYCLED PAPER

7981 **Muret**

Lápis perpétuo com corpo de cartão de fibra de trigo. Ponta em chumbo para escrita perpétua. Não é preciso afiar.

14 x Ø0,80 cm

50

1000

A(4)

PERPETUAL PENCILS



29



29



BAMBOO



7999 **Tikun**

Lápis eterno com corpo em bambu. Ponta em chumbo para escrita inacabável. Não é preciso afiar. Inclui borracha.

15 x Ø0,80 cm

1/50

1000

A(4), L1



BAMBOO

7998 **Bakan**

Lápis eterno com corpo em bambu. Ponta em chumbo para escrita inacabável. Não é preciso afiar.

15 x Ø0,80 cm

1/50

1000

A(4), L1



7999 **Tikun**

7998 **Bakan**

MULTI-TOOL



01 60 05 251 02

8024 **Kanchan**

Esferográfica multi ferramenta 4 em 1: nível, régua em centímetros e polegadas, chave de parafusos de cabeça plana e estrela. Corpo com acabamento metalizado, mecanismo giratório e clip metálico. Tinta azul.

 14,9 x Ø1 cm  1/50  1000

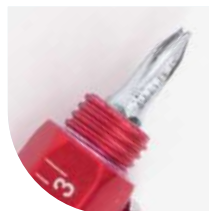
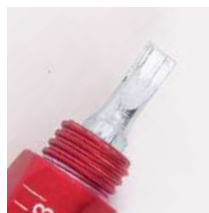

 B(4)



60 05 251 02

8023 **Araya**

Esferográfica lanterna de luz LED com corpo ABS metalizado. Mosquetão integrado na tampa. Tinta azul

 11 x Ø1 cm  1/50  500

 B(4)

CARPENTER PENCIL



8088 Veta

Lápis de carpinteiro em formato oval para uma fácil marcação. Ponta sem afiar.

17,6 x 1,2 cm 100 1000

A(4), L1

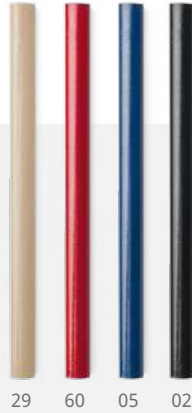

29 60 05 02

8003 Mata

Mini-lápis em madeira com acabamento em borracha natural. Corpo redondo.

10 x Ø0,50 cm 100 2000

A(4)



01 29 03 31 60 40 05 55 226 02

8002 Couvet

Lápis de cor em madeira redondo com borracha.

18,6 x Ø0,70 cm 100 2000

A(4), L1



+ antibacterial ISO 22196



01 03 31 40 60 05 226



8046 Gryfin

Lápis de madeira com tratamento anti bacteriano e borracha. Disponível em várias cores

18,6 x Ø0,70 cm 100 2000

A(4)





8049 Tilos

Conjunto infantil para colorir. Inclui bloco com desenhos, 6 lápis de cor e afia lápis. Apresentação em caixa de cartão reciclado.

7,4 x 1,5 x 9 cm 1/50 400

C(4), W

COLOUR AND FUN



8077 Pyrus

Kit infantil para colorir. Inclui blocos com vários tipos de desenhos, 12 lápis de cor.

10 x 1 x 9,5 cm 1/50 200

C(4)

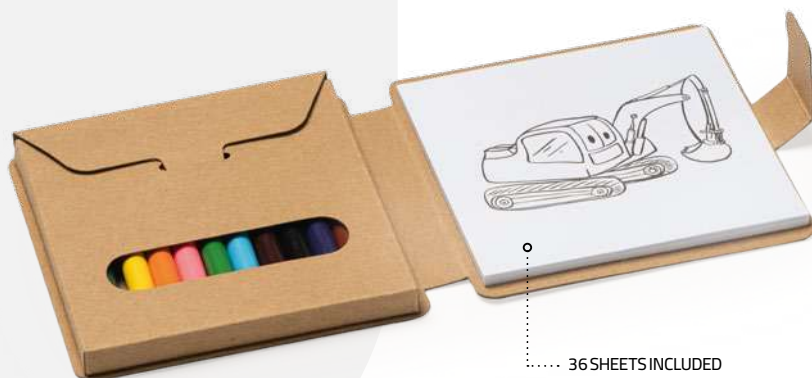

8069 Resol

Kit infantil para colorir. Inclui blocos com vários desenhos, 6 lápis de cor, apontadores e borrachas. Prática alça de transporte.

20 x 21 x 1,6 cm 1/40 80

D(1)



NEW.



7571 Solaz

Caixa de lápis em material não-tecido para crianças, com design para colorir. Inclui 5 unidades de giz de cera em cores variadas.

22 x 11 cm 1/50 200
 F(1)



8087 Vernak

Kit de escrita de madeira natural apresentado em caso de cartão kraft. Inclui: regra, 3 lápis, 1 borracha e 1 apontador.

17,7 x 1,3 x 4,5 cm 1/20 240
 B(4), W



8064 Lizana

Conjunto de 5 peças presentes em caixa de cartão kraft. Inclusive caneta com corpo de cartão e tinta azul, lápis de madeira, afia lápis, borracha e régua de 15 cm.

17,7 x 1,5 x 4,5 cm 1/50 400
 B(4), W

NEW YAMBI

NEW.

7989 Yambi

Conjunto giz grosso - 4 unidades. Cores azul, vermelho, verde e amarelo. Apresentação em caixa ecológica.

10,5 x 9,5 x 2,5 cm

1/50

100

B(4)



8092 Waldo

Conjunto de desenho com 13 peças. 6 lápis de cera, 6 lápis de madeira e um afia-lápis incluídos. Apresentação em porta-lápis de cartão.

10 x Ø4,60 cm

1/10

200

B(4), W



8000 Boreal

Conjunto de 6 lápis de cera em caixa de papelão reciclado.

5 x 8,3 x 0,8 cm

1/50

400

B(4), W



8001 Amazonia



Conjunto de 6 lápis de cor em madeira em caixa de papelão reciclado.

4,5 x 9 x 0,8 cm  25/25  500
 B(4), W



8089 Mabel

Conjunto de 6 lápis em madeira em estojo de cartão reciclado e tampa translúcida de cor. Inclui afia lápis integrado na tampa.

10,2 x Ø2,70 cm  1/50  400
 B(4), W



7996 Koel

Conjunto de 12 lápis de madeira em caixa de cartão reciclado.

9 x 9 cm  25  250
 B(4), W



7997 Denok

Conjunto de 3 lápis de madeira em caixa de cartão reciclado.

2,4 x 9 x 0,8 cm  50  1000
 B(4), W

PENCIL SET

NEW.



NATURAL CORK

NEW BALOK

MULTIPURPOSE FOLDER | A4 | MAGNETIC CLOSURE



NATURAL
CORK

7985 Balok

Pasta multiusos A4 em cortiça natural com fecho magnético. Bloco destacável com 30 folhas, 4 bolsos interiores e porta-caneta incluídos.

 24,5 x 31 x 1,5 cm  1

 20

 F(1), L2

NEW.



NEW/SAMAR



255



58



02



RECYCLED
PET

7984 **Samar**

Pasta multiusos A4 em urze 600D PET com fecho magnético. Bloco com 30 folhas destacáveis incluído. 4 bolsos internos e porta-caneta.

24,5 x 31 x 1,5 cm 1

20

G(1), N(8)



RECYCLED CARDBOARD

NEW.



7980 **Yasper**

Pasta em cartão reciclado. Bloco simples destacável com 20 folhas, caneta a condizer em fibra de trigo, bolso interior e suporte para cartão incluídos.

32 x 23 x 1,5 cm 1

50

B(1), F(1)

NEW.



7978 **Ledo**

Caderno A5. Capas duras com acabamento em bambu com função de suporte. Bookmark e 80 folhas forradas.

15 x 21 x 1,5 cm 1/20 40

E(1)

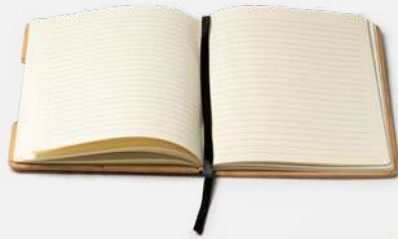

NOTEBOOKS | A5 | SUPPORTING FUNCTION

NEW.



255



58



02



7977 **Darit**

Caderno A5. Capa dura PET com função de suporte. Elástico, marcador e porta-caneta. 80 folhas.

15 x 21 x 1,5 cm 1/20 40

E(1)





NEW.

SIKAS
NEW

NOTEBOOK | A5 | SUPPORTING FUNCTION



7971 **Sikas**

Caderno A5 com capa dura PET. Caneta e suporte móvel incluídos. 80 páginas simples.

14,6 x 21,4 x 1,5 cm

1/25

50

E(1), W, T

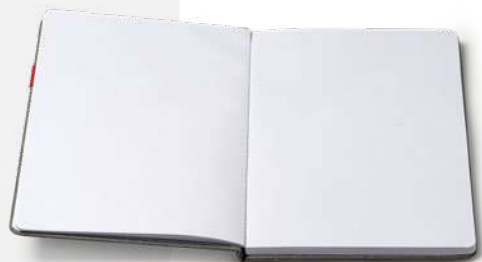



100%
RECYCLED
PET



RECYCLED
PET

7979 **Soyer**

Caderno A5 com capa dura em PET.
Marcador e elástico condizentes. 80 folhas.

14,7 x 21 x 1,5 cm 1/25 50

E(1)

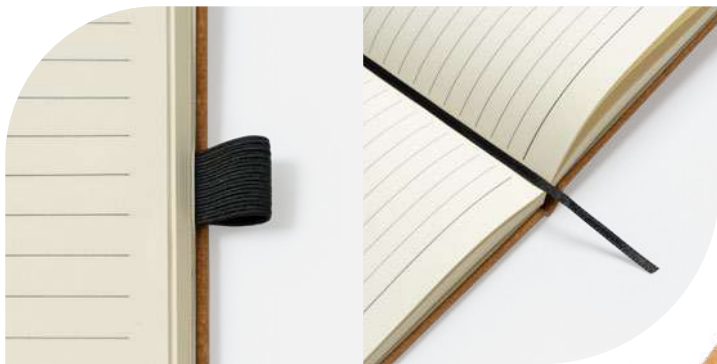

RECYCLED
LEATHER

7974 **Korum**

Caderno A5 com capa dura de pele reciclada.
Marcador e elástico. 100 folhas com linhas.

14,5 x 21 x 1,4 cm 1/25 50

E(4), L2



100% **RECYCLED** LEATHER



SET NOTEBOOK & PEN

WHEAT
FIBERNATURAL
CORK

COTTON

8081 **Robin** 

Bloco de notas A5 com coberturas rígidas de cortiça e algodão. 80 folhas lisas. Inclui suporte para canetas de cortiça e fibra de trigo a condizer. Tinta azul.

 15,2 x 21 x 1,4 cm  1/25  50

 E(1), B(1), N(8), L2, W

GALA



BAMBOO COVER | RECYCLED PAPER
BAMBOO BALL PEN



BAMBOO

8082 **Gala** 

Caderno de bambu e conjunto de canetas apresentado em estojo ecológico. Caderno com capa dura, 80 folhas de papel reciclado com uma linha. Esferográfica com detalhes cromados e tinta azul.

 22 x 24 x 2,2 cm  1/20  40

 E(1), B(1)



NEW.



7988 Andros

Caderno A5 com capa dura em cortiça natural. Marcador e elástico. 80 folhas.

14 x 21 x 1,5 cm 1/25 50
E(4), L2



8072 Cales

Bloco de notas A6. Capa rígida em cortiça natural. Marcador de páginas e banda elástica. 80 folhas.

8,9 x 14 x 1,4 cm 1/50 100
E(4), L2

NATURALCORK

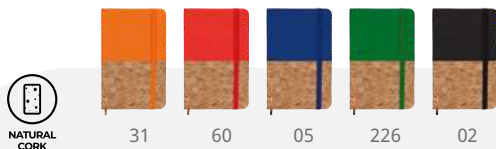

8071 Iris

Bloco de notas A6. Capa rígida mista cortiça / pele sintética. Marcador de páginas e banda elástica. 80 folhas.

9,3 x 14,3 x 1,5 cm 1/50 100
E(4), L2



PIANA



NEW.

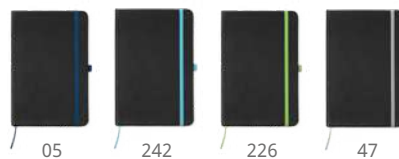

7987 Piana

Caderno A5 com capa dura em PU preto. Marcador colorido, elástico e porta-caneta. 80 folhas com linhas.

14 x 21 x 1,5 cm 1/25 50

E(4), T

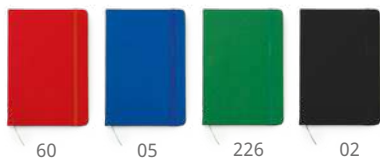

8091 Ardak

Bloco de notas A5 com capa rígida em imitação de pele. Marcador de páginas e banda elástica. 100 folhas de linhas.

14,7 x 1,5 x 21 cm 1/25 50

E(4), T, W





8051 **Coral**

8050 **Alba**

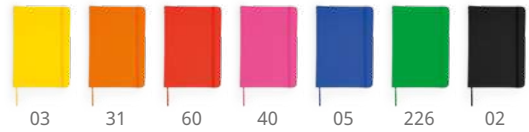

03 31 60 40 05 226 02

8050 **Alba**

Bloco de notas A5 com capa rígida em pele sintética. Marcador de páginas e banda elástica. 100 folhas.

14,7 x 21 x 1,5 cm 1/25 50

E(4), T



31 60 40 05 55 226 02

8051 **Coral**

Bloco de notas A6 com capa rígida em pele sintética. Marcador de páginas e banda elástica. 100 folhas.

9,3 x 14,3 x 1,5 cm 1/50 100

E(4), T

+ antibacterial
ISO 22196

8061 **Elion**

Bloco de notas A6. Capas em PU com tecnologia antibacteriana. Marcador e elástico. 80 folhas. Padrão ISO 22196.

9 x 14 x 1,4 cm 1/50 100

E(4)



8060 **Watson**

Bloco de notas A5. Capas em PU com tecnologia antibacteriana. Marcador e elástico. 100 folhas. Padrão ISO 22196.

14,9 x 21 x 1,4 cm 1/25 50

E(4)



8061 **Elion**

8060 **Watson**



01 03 31 60



05 226 40 02



7994 Leynax



Caderno espiral com folhas lisas e suporte para caneta. Capa dura e caneta em cartão reciclado condizente. 70 folhas.

15 x 1,9 x 18,2 cm 1/25 50

E(1), B(4)



31 60 05 226 02



8073 Alani



Caderno espiral com capa dura em cartão reciclado. Inclui caneta a condizer com tinta azul. 60 folhas.

16,5 x 21 x 1 cm 1/20 80

E(4)

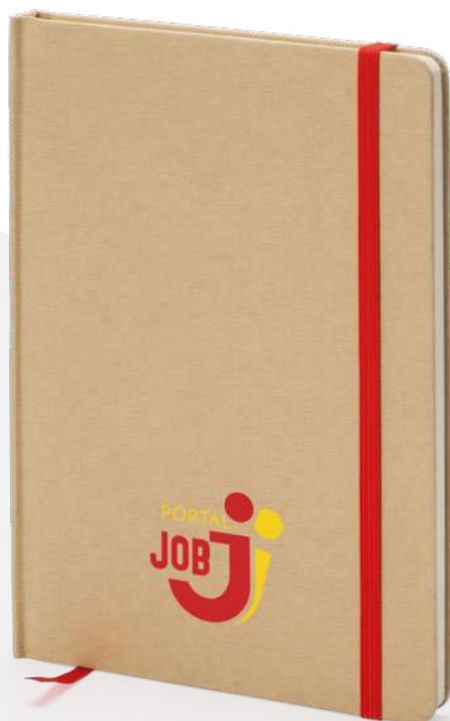

01 03 60 05 226 02



8070 Estela

Bloco de notas A5. Capa rígida em cartão reciclado. Marcador de páginas e banda elástica colorida. 100 folhas.

14,7 x 21 x 1,5 cm 1/25 50

E(4)



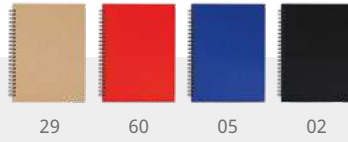
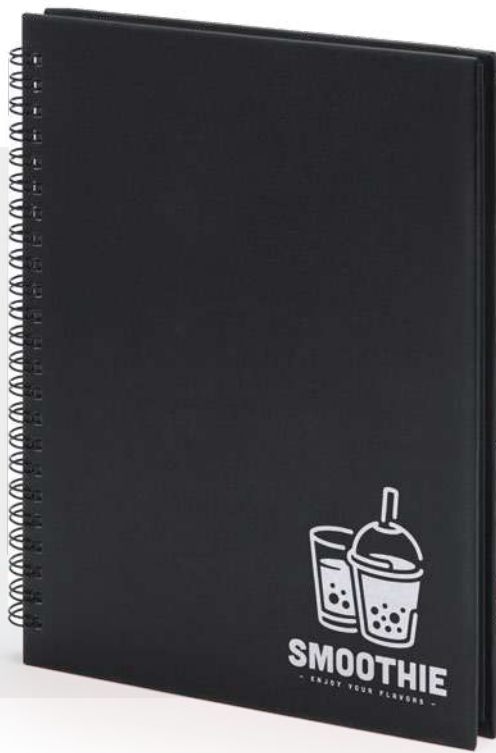

8052 **Valle**

Caderno espiral com folhas pautadas microperfuradas. Capa rígida em cartão reciclado. 80 folhas.

16,4 x 21,7 x 1,6 cm

1/25

50

E(4)

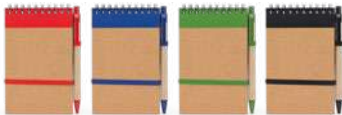

60

05

226

02



8074 **Lien**

Caderno espiral com capa dura em cartão reciclado. Inclui caneta a condizer com tinta azul. 70 folhas.

9,7 x 14,4 x 1 cm 1/50 100

D(4), B(4)



01

31

60

05

02

8054 **Arco**

Mini caderno com espiral e capa rígida em PP. 60 folhas pautadas. Inclui caneta com tinta azul.

7 x 9,5 x 0,7 cm 1/50 300

D(4), B(4)



NEW.
COLORS



29



60



05



04

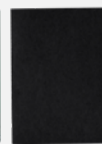

02



RECYCLED PAPER

8053 **Danica**

Caderno A5 em papel reciclado. 60 páginas com linhas.

14,5 x 21 x 0,8 cm 1/10 100

E(1)



RECYCLED PAPER

8055 **Saler**

Caderno A6 em cartão reciclado. 60 folhas.

10,5 x 14,5 x 0,8 cm 1/20 200

E(1)



BIODEGRADABLE PAPER COVERS

RECYCLED | DEGRADABLE | GROWING



RECYCLED
PAPER

8086 Sagra

Caderno A6 com cubertas de papel reciclável e degradável com semente. Inclui 40 folhas de papéis a uma listra. Apresentação em funda de papel kraft.

10,7 x 15 x 0,7 cm 1/100 200

E(1)



RECYCLED
PAPER

8085 Garo

Blocos de notas com capas de papel reciclável e degradável com sementes. Inclui 50 folhas de papéis reciclado.

7,2 x 10 x 0,8 cm 100 200

C(1)



RECYCLED
PAPER

8063 Bosco

Bloco de notas de desenho clássico com capas de cartão reciclado. 200 folhas brancas. Inclusive 125 notas adesivas de cores distintas.

8,1 x 2,6 x 8,3 cm 1/50 100

D(2), W



8056 Innis

Bloco de notas original em cartão reciclado com 100 notas adesivas em 5 cores sortidas.

5,4 x 8,2 cm

1/100 500

C(4)



01



29

8062 Dimas

Conjunto de escritório em cartão com forma de cubo, composto por lapiseiro, bloco de notas (250 folhas) e 180 notas adesivas de várias cores.

9 x 9 x 9 cm

1

40

D(2), W



8057 Anfi

Bloco de notas adesivas com anéis e desenho original em forma de sanduíche. Tampas rígidas de cartão reciclado. Inclui notas adesivas em cores sortidas em dois tamanhos: 100 grandes e 125 pequenos.

8,3 x 10,7 x 2,3 cm

1/50

100

D(4)





NATURAL
CORK



7546 **Vespula**

Estojo em cortiça natural com forro interior em poliéster e fecho.

23 x 11 x 2 cm 1/50 200

E(1), L2

NATURALCORK

CASES



01



03



31



60



05



226



02

7559 **Colina**

Caixa com acabamento em cor sólida com fecho zíper a combinar. Fabricado em poliéster 600D.

22 x 11 cm 1/20 400

E(1), N(8), O

CALENDARS 2024



8066 Flint

Calendário de escritório horizontal. Desenho mês actual / mês anterior / mês seguinte / calendário anual. Inclui o dia dos santos. Corpo em cartão ideal para marcação.

22 x 13,8 x 6 cm 50 200

E(4)



8067 Glen

Calendário magnético com folhas removíveis. Desenho do mês actual. Grande superfície de marcação.

10 x 19 cm 25 400

C(1)



8065 Dean

Calendário de escritório vertical. Desenho mês actual / mês anterior / mês seguinte / calendário anual. Inclui o dia dos santos. Corpo em cartão ideal para marcação.

10,8 x 13,8 x 6 cm 50 400

E(4)



01 60 05 226 02



60 05 55 242 226 02



450 55 02

8068 Hera

Agenda de tamanho A5. Tampus almofadadas de PU com gravação em relevo. 352 páginas. Desenho da página do dia com cantos cortados sob pressão.

15,8 x 21 x 2,4 cm 1 20

E(1), T, U

8059 Horus

Diário A5 diary com capa em PU acolchoado gravado em baixo relevo. 320 folhas e 4 páginas com mapas. Marcador condizente com a capa.

15 x 21 cm 1 20

E(1), T, U

8083 Selkis

Agenda com capa de PU almofadada gravada em baixo-relevo. 320 páginas bege mais 4 páginas com mapas. Bookmark para combinar com a capa. Apresentação em caixa branca.

17,6 x 24,5 x 2,1 cm 1

20

E(1), T, U



8020 Fenix

Calendário de mesa em PP. Com espaço ideal para personalização em tampografia.

14 x 4 cm

1/50

300

D(2)



BAMBOO

1002 Medus

Calendário de mesa feito de bambu. Formado por suporte e quatro blocos gravados. Apresentação em caixa ecológica.

13,6 x 4,6 x 5 cm

1/20

100

D(1), L2



01



60



05



226

3017 Serbal

Tapete de rato com calendário 2024. Capa translúcida em PVC, folhas removíveis com espaço para notas. Base antiderrapante.

23 x 18 x 0,4 cm

1/50

100

E(4)

BAGS & TRAVEL

NEW VOLANO



05

47

02



CABIN SIZE

7186 Volano **NEW.**

Mala com rodas rígida em ABS resistente. Dois compartimentos principais e bolso interior em rede. Trava de segurança embutida incluída.

34 x 51 x 20 cm  1  2

 K(1), L2



CABIN SIZE



BLEIK



55



47



02

7187 **Bleik**

Mala com rodas rígida em ABS resistente. Dois compartimentos principais e bolso interior em rede. Trava de segurança TSA embutida incluída.

 35 x 55 x 23 cm  1  1

 K(1), L2



NEW.





02



05



7178 **Garnes**

Mochila com rodas em poliéster heather 300D. Bolso principal espaçoso com compartimento acolchoado, ideal para portáteis de até 15". Dois bolsos com compartimentos interiores e bolso frontal. Estrutura resistente e de alta qualidade. Alças ajustáveis acolchoadas para os ombros. Revestimento das rodas resistente a manchas.

33,5 x 51 x 21 cm 1 4

1(8)



BACKPACK

GARNES



NEW WARKA

NEW.



7083 Warka

Mochila de viagem executiva em poliéster 300D. Dois bolsos acolchoados principais com compartimentos interiores e bolsos ideais para portáteis ou tablets. Alças para os ombros e costas acolchoadas. Faixa com bolso oculto e alça do carrinho.

32 x 41 x 14 cm 1

10

G(1), N(8), O, P



02



255



58



RECYCLED PET

7500 **Kalmar**

Pasta de documentos acolchoada para o seu portátil em poliéster reciclado 600D PET com acabamento em urze. Dois compartimentos com fecho impermeável. Alças correspondentes e alça de ombro com ajuste. Alça do carrinho incluída.

37 x 5 x 28 cm

1

30

F(1), N(8)



05



58



02



RECYCLED PET

7139 **Gregor**

Mochila em poliéster RPET 600D com acabamento em poliéster heather. Bolso principal acolchoado, ideal para o seu portátil ou tablet. Entrada USB integrada para ligar ao seu carregador portátil (não incluído). Bolsos laterais e frontal. Alças para os ombros e costas acolchoadas.

29 x 43 x 13 cm

1

20

F(1), N(8), O, P



RECYCLED PET



58



05

7566 **Kebal**

Capa acolchoada para portátil de 15'' em poliéster RPET 300D.

39,5 x 29 x 3,5 cm

1

30

F(1), N(8)



RECYCLED PET



58

255



7106 **Malmo**

Mochila feita de poliéster reciclado RPET 600D com design vigoré. Corpo acolchoado e bolso interior ideal para portátil. Compartimento duplo com fecho de correr à prova de água e bolso exterior. Punhos e alça do carrinho acolchoados.

31 x 42 x 12 cm 1 20

G(1), N(8)



7176 **Sidney**

Mochila produzida com poliéster reciclado RPET 600D com efeito vigoré. Corpo e bolsos interiores acolchoados. Ideal para portátil e tablet. Duplo compartimento e bolsos laterais. Asas acolchoadas.

31 x 45 x 13 cm 1 20

G(1), N(8)





02

58



NARVIK



7177 **Narvik**

Mochila em poliéster 300D. Design inovador com acabamento OXFORD. Bolso principal acolchoado, ideal para portátil, com dois bolsos frontais com fechos elegantes. Entrada USB integrada incluída para ligar a carregador portátil (não incluído). Alças para os ombros e costas acolchoadas.

31 x 43 x 16 cm 1 20

N(8), G(1)

ORMOK

DEXTER

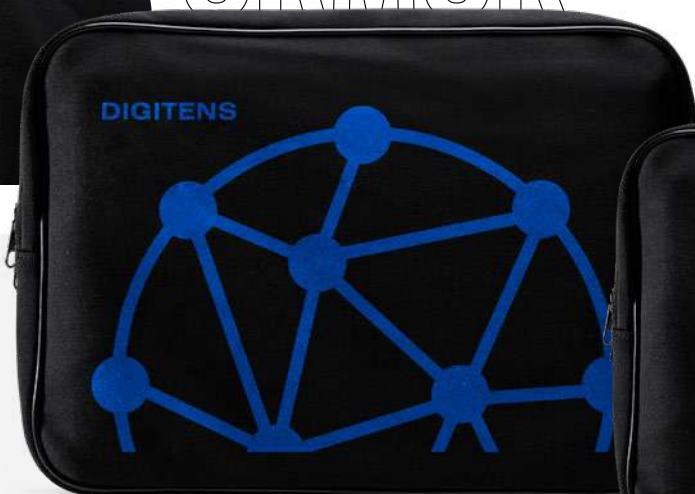

7568 **Ormok**

Capa acolchoada para portátil de 15" feita de espuma de alta densidade.

39 x 26,5 x 3,5 cm 1 25

F(1), N(8)



7567 **Dexter**

Capa acolchoada para portátil de 13" de espuma de alta densidade.

34 x 24 x 3 cm 1 25

F(1), N(8)

ANTI-THEFT

7172 **Moana**

Mochila anti-roubo fabricada em nylon. Compartimento com saída USB para ligar a uma bateria portátil (power bank) – não incluído. Micro cabo USB incluído. Bolso multiusos em tira direita. Bolso principal com dois compartimentos acolchoados ideal para portátil e tablet. Asas e costas acolchoadas.

 30 x 44 x 16 cm



1



10

 G(1), N(8)



55

02

7171 Duke

Mochila produzida em nylon. Bolso interior acolchoado ideal para portátil. Asas e costas acolchoadas. Compartimento com saída USB para ligação a bateria portátil (power bank) – não incluído. Inclui cabo micro USB.

30 x 45 x 20 cm



1



10

G(1), N(8)



02

58

55



7173 Mardok

Mochila produzida em nylon 600. Asas e costas acolchoadas. Inclui compartimento interior acolchoado para portátil.

32,5 x 44 x 25 cm  1  10

 G(1), N(8)



58

243

255



7146 Chucao

Mochila em poliéster com acabamento de design em urze. Acolchoado nas alças dos ombros, costas e alças. Compartimento frontal duplo e bolsos laterais. Etiqueta removível.

28 x 43 x 13 cm  1  15

 Consult





29

31

05



226

02

60



7515 Lora

Mala para documentos acolchoada para portátil em poliéster macio 600D com bolso exterior. Alças de transporte à cor e alça de ombro ajustável com mosquetão.

40,5 x 30 x 5,5 cm 1 50

F(1), N(8)



POLYESTER 900D



231

60

55

15

7138 Dodo

Mochila multifunções em poliéster 900D. Compartimento principal espaçoso dobrável com zíper e botões de pressão. Bolsos laterais. Alças para os ombros e costas acolchoadas. Etiqueta removível.

44 x 30 x 10 cm 1 10

Consult

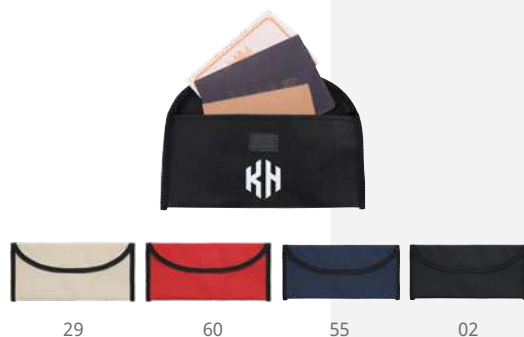
7518 **Garza**

Mala de viagem para documentos com fixação de velcro e alça para cinto útil. Poliéster 600D

27 x 13 cm

1/40

400

E(1), N(8)

7517 **Charran**

Mala para documentos em poliéster 600D em várias cores com pega de transporte e fecho de correr à cor.

40 x 29,5 x 5,5 cm 1/20 100

F(1), N(8)

7516 **Libe**

Mala para documentos em poliéster 600D com um compartimento principal e fecho de correr. Acabamentos reforçados e alça integrada no mesmo padrão.

38 x 32 cm

1/20

100

F(1), N(8)





NEW.

2991 **Covas**

Alarme pessoal, ativado pela separação do conector ligado ao porta-chaves. Apresentação em caixa de design.

3,9 x 6,1 x 1,9 cm 1/50 300

D(4)



ENJOY YOUR TRIP



3014 **Gordon**

Adaptador universal de viagem. Europa, Ásia, EUA, Austrália. Apresentação em caixa branca.

8,2 x Ø4,50 cm 1/50 100

D(4)



3013 **Bopp**

Adaptador de viagem universal compacto e retrátil. Luz led. Acabamento mate e toque suave. Europa, Ásia, Reino Unido, EUA, Austrália. 2 saídas USB. Velocidade de carregamento de 2100 mAh. Apresentação em caixa branca.

6,1 x 5,6 x 4,5 cm 1/50 100

D(1), W



01

02



55

258

02

8201 Ansar

Almofada insuflável ideal para viajar com uma sensação de camurça suave.

33 x 9 x 25 cm 1/20 200

F(1)



8200 Branta

Máscara de viagem feita em microfibra macia. Ajuste elástico duplo.

18,5 x 9 cm 1/100 1000

D(1), N(8)



TIME TO RELAX



03

60

40

05

226

8199 Noys

Tampões de ouvido em espuma EVA. Apresentação em estojo com corrente de transporte.

6,4 x Ø2,20 cm 1/200 1000

C(1)

NEW.



01

02

8151 Yllier

Sapatilhas unisexo produzidas em algodão / poliéster cómodo, com interior acolchoado. Inclui bolsa prática em no woven. Tamanho único 36 - 43.

11,5 x 29 x 1,7 cm 1/10 200

E(1), N(8)



NATURAL
CORK



1126 Podox

Kit de manicure com caixa de cortiça e fecho de pressão. Tesoura de aço inoxidável, pinças, cortador de unhas, lima e cortador de cutículas incluído.

11 x 6 x 2 cm 1/50 200

E(1), L1, N(8)



NEW.



NEW.



1125 Velvet

Kit de manicure numa bolsa de algodão com cordão. Lima de unhas e aparador incluídos.

12 x 7,8 cm 1/50 400

F(1), L1, N(8)

NEW.



8311 Chelsy

Kit de limpeza de sapatos, incluindo uma calçadeira, um pano de limpeza, 2 escovas e um polidor neutro. Apresentação em caixa metálica.

14 x 4,7 x 10 cm 1 80

G(1), L2





8206 **Petra**

Etiqueta para malas em cortiça. Inclui cartão interior.

6 x 11,7 cm 50/100 500

D(1), L1



9935 **Arnold**

Estojo de viagem transparente produzido em PVC com fecho hermético. Inclui sortido de recipientes práticos ideais para gel, champô e perfume.

19 x 19 cm 1 100

F(1)



8204 **Charter**

Etiqueta para mala em forma de carrinho. Inclui cartão interior.

5,5 x 9,5 x 0,4 cm 1/50 500

C(4)



BACK POCKET



7548 **Vultur**

Bolsa em poliéster 600D com dois compartimentos: frontal e traseiro. Fechos e puxador no zíper a combinar. Cinto ajustável.

25 x 17 x 8 cm 1/20 100
 F(1), N(8)

NEW CAMBRAI

NEW.



7573 **Cambrai**

Bolsa de cinto 210D PET com compartimento principal e fecho de correr.

38 x 12 x 13 cm 25 200
 E(1), N(8), O





01 60 05 226 02



7544 Adal

Porta moedas com 2 bolsinhos produzido em agradável couro sintético RPET com fechos a combinar.

10,5 x 9 cm 1/10 500
 D(1), L1



7542 Medea

Porta moedas produzido em agradável couro sintético com fecho a combinar. Inclui anilha chaveiro no seu interior.

10,5 x 7,5 cm 1/20 1000
 D(1), L1



NATURAL CORK

7545 Limosa

Porta moedas em cortiça natural com forro interior e fecho. Inclui anilha para transporte.

11 x 9 cm 1/100 800
 D(1), L2



NEW.



7570 Mauve

Bolsa em PU com um design de acabamento brilhante, com fecho de correr e puxador a condizer.

12 x 8,5 cm 1/10 1000
 D(1)

NEW.



7497 **Naro**

Saco de toucador multifuncional em 100 % algodão Fairtrade (180 g/m²). Bolso principal com fecho de correr e puxador a condizer.

21 x 13 x 8 cm 10 100
 F(4), N(8), O, P

FAIRTRADE COTTON

NATURAL HEMP



261



152



02



HEMP

7499 **Prado**

Saco de toucador multifuncional em tecido cânhamo (200 g/m²), com alça correspondente.

21 x 13 x 8 cm 1/10 100
 F(1), N(8)

NEW.





RECYCLED COTTON



29 60 05 226 02



RECYCLED
COTTON

7562 Remo

Estojo multiusos de algodão 100% reciclado com fecho de correr e pega a condizer.

21 x 12 x 3 cm 1/50 300

F(1), N(8), O

100% ORGANIC COTTON



60 05

226 29 02

7536 Delphis

Estojo sanitário 100% algodão orgânico 180 g/m² com pega a condizer.

21 x 16 cm 1/50 300

F(1), N(8), O



NEW.



7498 Zigari

Saco de toucador multifuncional em 100% algodão Fairtrade (180 g/m²). Bolso principal com fecho de correr e puxador a condizer.

23 x 17 x 6 cm 50 300

F(4), N(8), O, P

JUTE & COTTON



7563 Vera



Bolsa toallete feito de algodão e juta laminada.

 20 x 15 x 6 cm  1/50  200

 F(1), N(8)

7564 Siena

Bolsa de higiene feita em algodão e juta laminada. Zíper com puxador de juta combinando.

 21 x 11 x 6 cm  1/50  200

 F(1), N(8)

100% NATURAL



7560 Tyto

Bolsa de serapilheira natural com fecho a combinar. Puxador no zíper em serapilheira.

 22 x 14 x 6,5 cm  10  200

 F(1)



7558 **Sierra**

Bolsa de higiene multiusos em algodão 180 g/m² e sarapilheira. Fecho zíper com puxador de em sarapilheira a combinar

21,5 x 16 x 5 cm 10 200

F(1), N(8)

JUTE BAGS



2929

2960



2905

29226

2902

7537 **Doel**

Saco multiusos em algodão de 280 g/m² com acabamento bicolor. Fecho de correr com puxador em algodão a condizer.

22,5 x 17 x 5,5 cm 1/50 300

F(1), N(8)





SUBLIMATION



COTTON TOUCH

7569 Osak

Nécessaire, ideal para sublimação, em poliéster suave e com forro interior. Fecho de correr com puxador condizente.

22 x 14 x 6,5 cm 1/25 500

F(1), N(8), R

COSMETIC BAGS



01

60

05

226

02



RECYCLED PET

7547 Bubo

Estojo de banho com dois compartimentos com fechos e asa de transporte a combinar. Produzido em poliéster reciclado RPET 210D.

21 x 13 x 8 cm 1/20 100

F(1), N(8), O





29 31 60 05 02 40

7565 Sedna

Bolsa multiusos em poliéster 600D. Fecho com zíper a condizer.

22 x 14 x 6 cm 1/20 300
F(1), N(8), O



29 31 60 55 05 56 02

7513 Pardela

Estojo de toilette em poliéster 600D com fecho de correr e alça de transporte conveniente.

20 x 10 x 8 cm 1/10 200
F(1), N(8), O



29 31 60 05 02 40

7514 Yubarta

Estojo de toilette em poliéster 600D. Fecho de correr com puxador a condizer.

22 x 14 x 6 cm 10 300
F(1), N(8), O



01 03 31

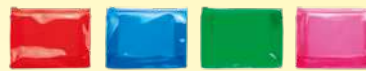

60 05 226 40

7511 Caribu

Estojo de toilette com fecho hermético em PVC translúcido.

17 x 13 x 5 cm 1/50 400
F(1)



05



255



02



RECYCLED
PET

7198 **Balmor** **NEW.**

Bolsa multifuncional em 300D PET com acabamento em urze. 30 litros de capacidade. Fecho de correr nos bolsos frontal e principal. Bolso lateral em rede. Alça ajustável para os ombros incluída.

50 x 28 x 24 cm 1 20

G(1), N(8), O, P



NEW BAL MOR



PROTECT
YOUR STUFF



60



55



02

7170 **Novak**

Mala duffel espaçosa multifunções em poliéster 600D. 5 compartimentos com fecho de correr. Base reforçada. Inclui alça ajustável acolchoada para os ombros.

65 x 33 x 34 cm 1 20

G(1), N(8)

MONDELO



NEW.

RECYCLED
COTTON320
g/m²7616 **MondeLO**

Saco de pano multifunções em algodão reciclado 320 g/m² e acabamento em design de poliéster heather. Capacidade para 24 L. Bolso principal com fecho de correr. Alças ajustáveis e confortáveis para os ombros.

49 x 24 x 26 cm 1 30

F(4), N(8), O, P



60

05

226



29

02



NEW.



29

60

05

226

02

RECYCLED
COTTON320
g/m²7179 **FirenZA**

Mochila em algodão reciclado 320 g/m² com acabamento em poliéster heather. Bolso frontal e alças acolchoadas para os ombros.

43 x 34 x 9 cm 1/10 30

F(4), N(8), O, P

FIRENZA



60

05

55

02

7115 Falco

Mochila bicolor em poliéster 900D com bolso acolchoado para calçado. Bolso principal com zíper duplo e bolso exterior frontal. Capacidade - 30 litros.

32 x 46 x 20 cm

1

10

Consult



60

05

55

02

7120 Columba

Mochila bicolor em poliéster 900D com bolso acolchoado para calçado. Bolso principal com zíper duplo e bolso exterior frontal. Capacidade - 38 litros.

32 x 42 x 28 cm

1

10

Consult



7182 Oblak

Saco de sapatos em poliéster 600D. Alça prática para transporte incluída.

35 x 15 x 16 cm 1/25 100

F(1), N(8), O

NEW.



ENJOY YOUR TRAVEL



60

05

55

02

7121 Canary

Saco desportivo com asa dupla e alça ajustável amovível. Bolso principal com zíper duplo. Bolso para calçado com compartimento amovível. Anti humidade. Base com tacos. Fácil limpeza. 53 litros de capacidade.

48 x 42 x 26 cm 1 10

Consult

NEW OTAWA

NEW.

60



05



226



02

7183 Ottawa

Mochila desportiva em nylon antirrasgões 210D de alta resistência. 30 litros de capacidade. Compartimento principal duplo com fecho de correr e bolsos interiores. Compartimento com cordão elástico frontal e bolsos laterais em rede. Alças para os ombros e costas acolchoadas. Alça lateral ajustável incluída.

32 x 47 x 20 cm

1

20

G(1), N(8)





7181 Misuri

Mochila de desporto em poliéster 600D. Fecho de correr nos bolsos principal e frontal. Cordão elástico frontal e bolsos laterais em rede. Alças para os ombros e costas acolchoadas.

30 x 45 x 14 cm 1 40
F(1), N(8)



7153 Condor

Mochila de poliéster 600D com fecho de zíper. Bolso frontal com saídas para cabos. Bolsos laterais de design micro-perforado. Etiqueta removível.

30 x 40 x 18 cm 1 40
F(1), N(8), O



7154 Sison

Mochila leve e compacta, Em poliéster resistente 600D. Bolso frontal com abertura vertical e alcochoado nas costas e alças. Etiqueta removível.

23 x 40 x 12 cm 1 50
F(1), N(8), O, R





03 31 60 55 05



12 226 15 78 02

7124 Marabu

Mochila clássica em poliéster 900D com compartimentos espaçosos. Alças para os ombros e costas acolchoadas. Etiqueta removível.

30 x 40 x 18 cm 1 20

Consult



256 248 246



135 243 252

7145 Teros

Mochila clássica em poliéster 300D com acabamento de design em urze. Bolso frontal com ilhós de cabo. Alças para os ombros e costas acolchoadas. Detalhes em preto. Etiqueta removível.

30 x 40 x 12 cm 1 20

Consult

DAVIDA/C



7174 **Wilde**

Mochila produzida em poliéster 600D com dois compartimentos principais e bolso frontal. Bolso lateral em rede. Asas e costas acolchoadas.

31 x 41 x 16 cm 1 40

F(1), N(8), O, P



7158 **Tucan**

Mochila clássica de poliéster 600D com compartimento principal e bolso frontal. Fecho de zíper com puxador para fácil abertura, com saída para cabos. Costas e alças acolchoadas. Etiqueta removível.

28 x 38 x 12 cm 1 50

F(1), N(8), O, P



226

60

05

02



7087 **Brest**

Saco de cordões em 100% algodão orgânico (140 g/m²), com alças em cor natural.

37 x 41 cm

50

200

F(4), N(8), P, O

NEW.



ORGANIC COTTON

NEW BARONE



7085 **Barone**

Saco de cordão em 100% algodão Fairtrade (180 g/m²), com cordões correspondentes.

38 x 42 cm

50

150

F(4), N(8), O, P

NEW.



ORGANIC COTTON



7098 **Muna**

Mochila de cordão 100% algodão orgânico.

38 x 42 cm

20

100

F(6), N(8), O, P



NEW.



60

55

02

7091 **Luanda**

Saco de cordões de algodão reciclado com acabamento em urze e 120 g/m² de algodão natural. Alças em cor natural.

38 x 42 cm 20 100

F(1), N(8), O, P

NEW LUANDA



29

60

05

226

02

7165 **Brescia**

Mochila de cordões em algodão reciclado de 120 g/m² com acabamento marmorizado e cordões em cor natural.

38 x 42 cm 50 100

F(4), N(8), O, P



29

60

05

226

02

7107 **Varese**

Mochila de cordão 100% algodão reciclado 140 g/m² em acabamento marmorizado com alças de 70cm de comprimento e cordões de cor natural.

38 x 42 cm 20 100

F(6), N(8), O, P

NATURAL HEMP

NEW.



200 g/m²



261



152



02

7090 **Naska**

Saco de cordão em tecido cânhamo (200 g/m²), com alças correspondentes.

38 x 42 cm

10

100

F(1), N(8)



01



31



60



05



226



02

105 g/m²

7175 **Adare**

Mochila 100% algodão com cordões no mesmo tom.

37 x 41 cm

10

100

F(6), N(8), M, O, P



120 g/m²

7557 **Wilkes**

Mochila com cordão, em algodão 120 g/m² e sarapilheira

34 x 43 cm

10

100

F(6), N(8), O, P



140 g/m²

7137 **Mirlo**

Mochila de cordões em 100% algodão de 140 g/m².
Cardaços de 8mm. Etiqueta removível.

34 x 42 cm

10

200

F(6), N(8), O, P

NEW.

7084 **Bremen**

Bolsa de cordão multicolorida em poliéster 210D.

36 x 42 cm

50

200

F(1), N(8)

7180 **Kanda**

Mochila de cordão, ideal para sublimação, em poliéster macio e resistente.

34 x 42 cm

10

100

F(1), N(8), R

NEW LABUR

HIGH VISIBILITY BACKPACK



NEW.



221



223



60



05

7184 **Labur**

Saco de cordões com tira de alta visibilidade, em poliéster 210D.

34,5 x 41 cm

10

300

F(1), N(8)



7157 **Zorzal**

Saco desportivo com cordão em design simples para fácil personalização. Cordas condizente. Bolso interior com fecho de correr. 100% poliéster 600D. 150 g/m².

35,5 x 42,5 cm 10 200
F(1), N(8), O, P



7150 **Cuanca**

Mochila de cordões com ilhós metálicos, realizada em poliéster 210D. Bolso frontal de design micro-perforado com fecho de zíper e saída para cabos. Etiqueta removível.

34 x 43 cm 10 200
F(1), N(8)



7152 **Ninfa**

Mochila de cordões com esquinhas reforçadas realizadas em poliéster 210D. Bolso frontal com zíper e saída para cabos. Etiqueta removível.

34,5 x 45 cm 10 200
F(1), N(8), R



7155 **Kagu**

Mochila com cordões grossos a jogo realizada em poliéster 210T. Cordões de 8 mm. Etiqueta removível.

35 x 45 cm 10 200
 F(1), N(8), R



7550 **Larus**

Mochila com cordão em poliéster RPET macio com cantos reforçados.

34 x 42 cm 50 300
 F(1), R



7114 **Hamelin**

Mochila de cordões com ilhós de metal, realizadas em poliéster 210D. Etiqueta removível.

34 x 42 cm 50 300
 F(1), N(8), R



991



992



993

7526 Milano

Mochila com cordões em poliéster 190T. Com design desportivo.

43,5 x 43 cm

50

300

F(1), N(8)



01

03

31

60



05

226

02

78

7151 Calao

Mochila de cordões com olhais metálicos realizada em non-woven 80 g/m². Etiqueta removível.

36 x 42 cm

10

300

F(1)



995



996



997



998

7528 Elanio

Mochila infantil de corda dobrável em poliéster 190T. Bolso dobrável com desenhos de animais.

26,5 x 32,5 cm

10

500

F(1), G(1)



9131 Pachu

Avental infantil em não-tecido com desenho para colorir. Inclui 5 lápis de cera em várias cores. Tamanho único ajustável.

43 x 43 cm 1/50 200

F(1)



7530 Turcaz

Mochila infantil de corda feita de não-tecido. Com desenhos para colorir. Inclui 5 lápis de cera em cores variadas.

25 x 30 cm 1/50 200

G(1)



7529 Azor

Saco infantil para colorir em não-tecido. Inclui 5 lápis de cera em cores variadas.

20,5 x 22 cm 1/50 100

F(1)



NEW.

7571 Solaz

Caixa de lápis em material não-tecido para crianças, com design para colorir. Inclui 5 unidades de giz de cera em cores variadas.

22 x 11 cm 1/50 200

F(1)

NEW SOLAZ





NEW.



03 60 05 226 02

7197 **Lubin**

Saco refrigerador dobrável em poliéster 190T. Forro de alumínio isotérmico e fecho de correr. Alças reforçadas. Fácil de dobrar com fecho.

45 x 36 x 9 cm 1/20 100

G(1)



10 05 47

NEW.

7088 **Sakra**

Mochila refrigeradora em poliéster antirrasgões 210D. Forro isotérmico nos bolsos principal e frontal. Compartimento com cordão elástico frontal e bolsos laterais em rede. 20 litros de capacidade. Alças acolchoadas para os ombros e costas.

26 x 40 x 19 cm 1 10

G(1), N(8)





BISMAR

MARLOX



255

243

7608 **Bismar**

Geladeira de poliéster reciclada RPET com design vigoré. Bolso frontal e interior isotérmico. Inclui correia de transporte ajustável.

25 x 15,5 x 15,5 cm



F(1), N(8)



255

243

7609 **Marlox**

Geladeira XL de poliéster reciclado RPET com design vigoré. Duplo compartimento e bolso frontal. Interior isotérmico. Inclui correia de transporte ajustável.

30 x 25 x 20 cm



F(1), N(8)



NEW.



55

02

7089 **Lombok**

Mochila refrigeradora em PET. Forro isotérmico no compartimento principal e bolso na aba. Bolsos laterais em rede. 19 litros de capacidade. Alças para os ombros e costas acolchoadas.

30 x 43 x 15 cm



G(1), N(8)





60



05



02

7605 Grulla

Mala refrigeradora multiusos em poliéster 600D. Compartimentos interiores isolados e bolsos exteriores práticos. Alça de ombro acolchoada ajustável com mosquetão.

25 x 24 x 15 cm 1 20

G(1), N(8)

NEW BAYONA



60



05



226



02

NEW.

7086 Bayona

Saco refrigerador multifuncional em poliéster 600D. Bolso principal isotérmico e frontal prático. Alça de transporte ajustável incluída.

26 x 34 x 19 cm 1 20

G(1), N(8)





7604 **Graja**

Mochila refrigeradora com cordões e interior em alumínio isolado. Exterior em poliéster 210D.

32 x 42 cm

1/10

200

G(1), N(8)

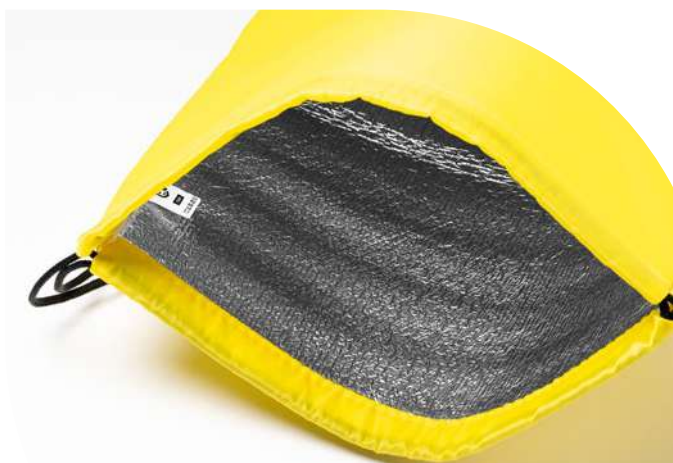

TIBU



7603 **Tibu**

Mala refrigeradora com interior em alumínio isolado para 6 latas. Exterior em PVC durável. Alça de transporte a condizer e fecho de correr.

21 x 15 x 15 cm

1/25

200

F(1), N(8)



7607 **Milana**

Saco em papel laminado de desenho clássico, interior isotérmico de alumínio e lapela com fecho de correr. Inclui asa prática para transporte.

19 x 13,5 x 14 cm 25 100

F(1)

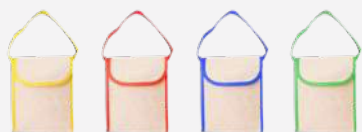

03

60

05

226

7606 **Serreta**

Saco em papel laminado, com interior isotérmico de alumínio. Lapela com fecho de correr. Inclui asa prática para transporte.

20 x 25 x 10 cm 10/50 100

F(1)



7600 **Kemer**

Bolsa térmica de papel laminado com interior isotérmico de alumínio. Alça e bolso externo com fecho de velcro.

19 x 32 x 12 cm 25 100

F(1)

4130 **Buren**

Lancheira para sandes em papel laminado resistente com fecho de correr. Revestimento interior em alumínio isotérmico. Alça prática para transporte incluída.

21 x 8 x 7,5 cm 1/25 200

F(1)



NEW.

NEW.



01

03

60

05

226

02

4131 **Rigax**

Lancheira para sandes em PVC com fecho de correr. Revestimento interior em alumínio isotérmico. Alça prática para transporte incluída.

21 x 8 x 7,5 cm 1/20 200

E(1), N(8)



01

60

05

226



RECYCLED
PET

7599 **Lombas**

Bolsa para sandes reutilizável em poliéster RPET com revestimento interno em PEVA isotérmico. Fecho em velcro. Fácil de limpar.

18 x 18 cm 1/25 500

F(1)

NEW.



NEW.



01 60 05 226 02



7195 **Kimex**

Sacola em 100% algodão Fairtrade (180 g/m²), com alças reforçadas de 70 cm de comprimento.

38 x 42 cm 10 100
 F(4), N(8), O, P

FAIRTRADE BAGS

NEW.



7194 **Valmir**

Sacola em 100% algodão Fairtrade (180 g/m²), com alças reforçadas de 70 cm de comprimento.

38 x 42 cm 50 150
 F(4), N(8), O, P





NEW.



261

152

02

200
g/m²7191 **Serpa**

Sacola em tecido cânhamo (200 g/m²). Alças reforçadas de 70 cm de comprimento.

38 x 42 cm

10

100

F(1), N(8)

HEMP HEMP



261

152

02

200
g/m²7190 **Mafil**

Saco com reforço em tecido cânhamo (200 g/m²). Alças reforçadas de 70 cm de comprimento.

38 x 42 x 10 cm

10

100

F(1), N(8)



NEW.



7167 **Greta**

Bolsa 100% algodão orgânico de 300 g/m² com práticas alças longas de 70 cm.

40 x 40 cm 10 100
F(4), N(8), O, P

ORGANIC COTTON



7168 **Kensal**

Bolsa 100% algodão orgânico de 280 g/m² com fole e práticas alças longas de 70 cm.

38 x 42 x 9 cm 10 100
F(4), N(8), O, P



7159 **Narbona**

Bolsa 100% algodão orgânico de 120 g/m² com alças longas reforçadas de 35cm.

40 x 40 x 10 cm 20 200
F(4), N(8), O, P



NEW.



163

261

262

264

ORGANIC
COTTON7193 **Bondy**

Sacola em 100% algodão orgânico (140 g/m²), com alças reforçadas de 70 cm de comprimento.

38 x 42 cm

50

200

F(4), N(8), P, O

NATURAL BAGS

ORGANIC
COTTON7156 **Berna**

Bolsa 100% algodão orgânico de 120g/m² com alças longas reforçadas de 70cm.

38 x 42 cm

50

200

F(4),N(8),O,P



29

60

05

226

02

7162 **Rivoli**

Bolsa 100% algodão reciclado 120 g/m² em acabamento marmoreado com alças de 70cm.

38 x 42 cm

50

200

F(4), N(8), O, P

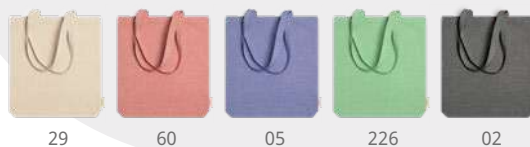

29

60

05

226

02

7617 **Lumia**

Saco feito em algodão reciclado 140 g/m² com acabamento em poliéster heather, e alças longas de 70 cm.

38 x 41 x 8,5 cm

1/50

200

F(4), N(8)



29

60

05

226

02

7107 **Varese**

Mochila de cordão 100% algodão reciclado 140 g/m² em acabamento marmoreado com alças de 70cm de comprimento e cordões de cor natural.

38 x 42 cm

20

100

F(6), N(8), O, P



60

05

02

NEW.**7189 Inca**

Saco de cordão feito de algodão reciclado com acabamento em urze e 120 g/m² de algodão natural com reforço. Alças reforçadas de 70 cm de comprimento.

 38 x 41 x 8 cm  20  100

 F(1), N(8), O, P

RECYCLED COTTON

NEW.



60

05

02

7188 Palmira

Saco de cordão feito de algodão reciclado com acabamento em urze e 120 g/m² de algodão natural. Alças reforçadas de 70 cm de comprimento.

 38 x 42 cm  20  200

 F(1), N(8), O, P

100% NATURAL COTTON

SAME DESIGN | DIFFERENT WEIGHT

105
g/m²

7520 **Hillock**

Saco de compras em 100% algodão de 105 g/m² costurado. Com práticas alças reforçadas de 70 cm.

 37 x 41 cm

 50

 250

 F(4), N(8), O, P

140
g/m²

7601 **Hill**

Bolsa de compras realizada em 100% algodão de 140 g/m², com alças longas de 70 cm.

 37 x 41 cm

 20

 200

 F(4), N(8), O, P

180
g/m²

7551 **Zenith**

Bolsa de compras 100% algodão 180 g/m² costurado. Com alças práticas reforçadas com 70 cm de comprimento.

 37 x 41 cm

 50

 150

 F(4), N(8), P

PUPPYPAWS
YOUR ONLY ONE STOP PET STORE

100% NATURAL COTTON

NEW.



7521 **Knoll**

7160 **Niza**

7602 **Mountain**

7196 **Berlin**



03 60 05 226 02

7160 **Niza**

105
gr/m²

Bolsa 100% algodão orgânico de 105 g/m² com alças longas de 70cm. A cor.

37 x 41 cm 50 200

F(4), N(8), O, P



NEW.

119

7196 **Berlin**

180
gr/m²

Sacola em algodão Fairtrade 100% (180 g/m²), com alças reforçadas de 70 cm de comprimento.

38 x 42 cm 50 150

F(1), N(8), O, P



01 03 31 60



40 05 226 02

7521 **Knoll**

105
gr/m²

Saco de compra em 100% algodão colorido de 105 g/m² costurado. Com práticas alças reforçadas de 70 cm.

37 x 41 cm 50 250

F(4), N(8), O, P



01 03 31 60 40 05 226 02



48 63 55 242

NEW.
COLORS

7602 **Mountain**

140
gr/m²

Bolsa de compras em 100% algodão de 140 g/m² em cores, com alças longas de 70 cm.

37 x 41 cm 20 200

F(4), N(8), O, P



105 g/m²

7519 Baguette

Saco em 100% algodão de 105 g/m² costurado com tamanho clássico para pão. Fecho de cordão grosso.

20 x 58 cm 10 500
F(1), N(8), O, P

100% COTTON



105 g/m²

7525 Dune

Saco de compras dobrável em 100% algodão de 105 g/m². Com alças de 70 centímetros e alça dobrável ajustável.

37 x 41 cm 10 200
F(4), G(4), N(8), P



180 g/m²

7553 Leaf

Bolsa de compras em algodão de 180 g/m² com acabamento liso e malha. Alças reforçadas com 60 cm.

45 x 42 cm 10 100
F(4), N(8)

120 g/m²7615 **Zapax**

Saco com cordões em algodão 120 g/m². Perfeito para guardar sapatos.

42 x 34 cm

50

200

F(4), N(8)

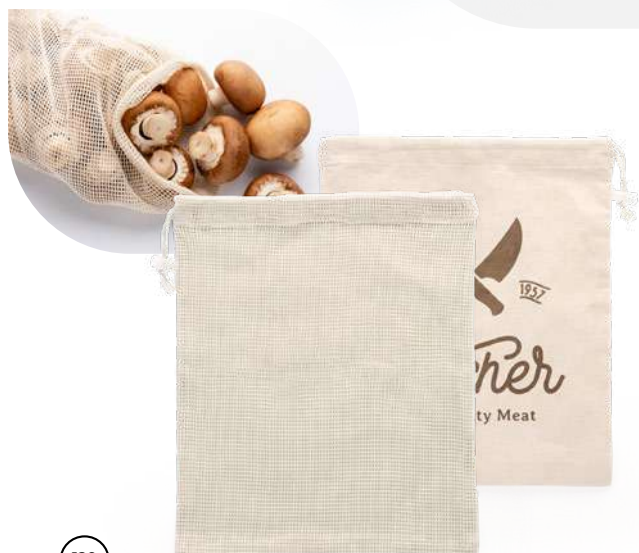
120 g/m²7554 **Soil**

Bolsa de algodão 120 g/m². Uma lado da bolsa com desenho simples e a outra face com desenho de malha. Fecho com cordão ajustável.

25 x 30 cm

50

250

F(4), N(8)

105 g/m²7552 **Ardea**

Bolsa de algodão 105 g/m² com cordões para fechar

15 x 21 cm

50

500

F(4), N(8), O, P

NATURELOVERS

120 g/m²7614 **Napa**

Saco com cordões em algodão 120 g/m². Ideal para garrafas e garrafas térmicas.

12 x 33 cm

50

400

F(4), N(8)



NEW.

COTTON & JUTE

NEW RAKU

NEW.

110
g/m²7185 **Raku**

Saco dobrável em 100% algodão (110 g/m²) com fundo em juta. Bolso exterior incluído. Alças reforçadas de 60 cm. Fácil dobragem e fecho de correr.

35 x 39 x 10 cm 10 100

G(6), H(6), N(8)



JUTE & COTTON



29

60

226

05

7110 **Nantes**

Bolsa de juta laminada com uma cara de algodão ideal para marcação e alças compridas.

40 x 16 x 32 cm 10 50

F(4)

120
g/m²7556 **Wave**

Bolsa de compras em algodão 120 g/m² e sarapilheira. Com alças práticas e reforçadas de 70 cm.

37 x 41 cm 10 200

F(6), N(8), O, P



o..... ISOTHERMAL INTERIOR

7161 **Venice**

Bolsa térmica de juta laminada. Interior isotérmico de alumínio com fecho de velcro. Bolso frontal e alças em algodão natural.

43 x 20 x 34 cm 10 40

F(1), N(8)

7099 **Gavia**

Bolsa de juta laminada com bolso frontal e alças compridas em algodão natural.

48 x 15 x 35 cm 10 80

F(1), N(8)





7149 **Nimes**

Bolsa de juta natural com tubagem de algodão e alças reforçadas. Acabamento costurado

 38 x 41 cm

 10

 80

 F(1), N(8)

29

7148 **Koper**

Bolsa de juta natural com tubagem de algodão e alças reforçadas. Acabamento costurado

 38 x 42 x 16 cm

 10

 50

 F(1), N(8)



7555 **Sterna**

Bolsa de serapilheira natural com alças de algodão de 70 cm

44,5 x 35 x 14 cm  5

 60

 F(1)

100%
JUTE

7164 **Flay**

Bolsa estilo saco de juta natural. Fechamento com atacadores de algodão.

25 x 32 cm

 20

 200

 F(1),N(8)

7163 **Parma**

Bolsa estilo saco de juta natural. Fechamento com atacadores de algodão.

14 x 22 cm

 20

 400

 F(1),N(8)



7610 **Grace**

Saco de juta laminada com visor e compartimento duplo. Ideal para garrafas. Alças reforçadas.

20 x 34,5 x 10 cm 10 50

G(1), N(8)



7613 **Loire**

Saco de juta laminada e algodão. Compartimento duplo e alças reforçadas. Ideal para duas garrafas.

20 x 35 x 35 cm 10 60

F(4), N(8)



7612 **Belona**

Saco de juta laminada e algodão. Alças reforçadas. Ideal para garrafas.

11 x 35 x 10 cm 20 80

F(4), N(8)

EVERY
DETAIL
MATTERS



7611 **Nimba**

Saco de juta laminada com visor. Alças reforçadas. Ideal para garrafas.

10,5 x 35,5 x 10 cm

25

100

G(1), N(8)

7122 **Olmo**

Bolsa de papel de 80 g/m² em acabamento natural. Pegas curtas reforçadas com desenho plano. Ideal para hotéis e restaurantes (take away).

 30 x 29 x 20 cm  200

 F(1)



COTTON HANDLES



7123 **Pinus**



Saco de papel de 100 g/m² em acabamento natural. Pegas curtas reforçadas com desenho encarcado. Ideal para garrafas.

 12 x 36 x 10 cm  100  400

 F(1)

7561 **Milvus**

Saco em papel laminado 130 g/m² resistente com asas de algodão

 32 x 37,5 cm  1  250

 F(1)



29 01 60 55 02

7541 Maple

Bolsa de papel de 110 g/m². Alças curtas reforçadas com desenho encaracolado.

41 x 32 x 12 cm 200

F(1)



29 01 60 55 02

7540 Roble

Bolsa de papel de 110 g/m². Alças curtas reforçadas com desenho encaracolado.

32 x 40 x 12 cm 250

F(1)



29 01 60 55 56 02

7539 Haya

Bolsa de papel de 110 g/m². Alças curtas reforçadas com desenho encaracolado.

22 x 23 x 9 cm 250

F(1)



29 01 60 55 56 02

7538 Arce

Bolsa de papel de 110 g/m². Alças curtas reforçadas com desenho encaracolado.

25 x 31 x 11 cm 250

F(1)



RECY CLING SET

7147 Volga

Conjunto de 3 sacos de reciclagem. Feitos de tecidos laminados mate resistentes com fechos laterais de velcro. Alças reforçadas. Capacidade de cada saco: 40 litros.

99 x 44 x 28 cm 1 40

F(1)



01 31 60 05 226 02

7543 Coast

Saco reutilizável com acabamento laminado brilhante. Tecido PP resistente de 120 g/m² com alças de nylon reforçado e debrum preto a condizer.

39 x 39 x 15 cm 20 100

F(1)





01 03 31 60



40 05 226 02

RECYCLED
PET

7534 Phoca

Saco reutilizável cosido com acabamento laminado mate. Fabricado em no-woven RPET 100 g/m² reciclado com asas reforçadas.

41 x 37 cm

10

250

F(1)



01 60 05 226

RECYCLED
PET

7535 Orca

Bolsa reutilizável cosido com acabamento laminado mate. Fabricado em no-woven RPET 100 g/m² reciclado com alças reforçadas e debruado a combinar.

42 x 35 x 15 cm

10

200

F(1)



01 60 05 226 02

RECYCLED
PET

7549 Pantala

Bolsa de compras dobrável fabricado com RPET de poliéster reciclado macio. Inclui bolsa prática para dobrar.

33 x 46 x 8 cm

20

400

F(1), G(1), R



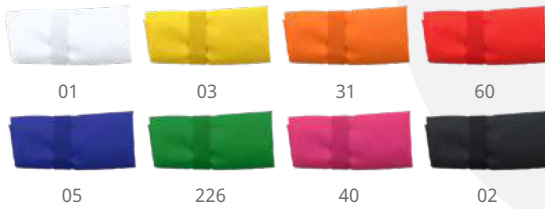

7522 Toco

Saco de compras dobrável em poliéster 190T macio com acabamento costurado. Inclui elástico prático para dobrar.

📏 42,5 x 38 x 7 cm 📦 1/20 📦 400

🔗 F(1), G(1), H(1), R



7523 Focha

Saco de compras dobrável em poliéster 190T macio. Vários designs de frutas com fecho de cordão.

📏 40 x 38 cm 📦 10 📦 400

🔗 F(1), G(1)



SHOPPING
BAGS



7128 **Trevel**

Capa de fiambre feita de não tecido resistente com pegas reforçadas e fecho de correr. Acabamento costurado.

 68 x 41 cm

 1/50

 100

 F(1)

NON WOVEN PRODUCTS



01

31

60

05

226

02

7166 **Barnet**

Bolsa de tamanho grande realizada em non-woven de 80 g/m². Alças reforçadas de 58 cm e acabamento de costura.

 33 x 38 x 25 cm

 10

 200

 F(1)



7125 **Boden**

Saco não-tecido 80 g/m². Alças curtas reforçadas de 35 cm e acabamento termo-selado.

38 x 35 cm 50 250
 F(1)

COLORFULL BAGS



7503 **Lake**

Saco de non-woven 100 g/m² selado termicamente com alças curtas.

35 x 40 x 12 cm 50 250
 F(1)



57 55 56 02

7502 River

Saco termicamente com desenho especial para garrafas. Alça integrada no corpo. Fabricada em non-woven 80 g/m².

17 x 40 x 10 cm 50 1000

F(1)



01 60 55 236 99 02

7501 Ocean

Saco selado termicamente em material non-woven 80 g/m² com alça integrada no corpo.

40 x 30 x 10 cm 50 400

F(1)



01 60 78 99



236 226 02

7504 Sea

Saco de non-woven 80 g/m² selado termicamente com alças compridas e fole hexagonal.

54 x 40 x 10 cm 50 250

F(1)

NON WOVEN SUBLIMATION BAGS



7506 Crest

Saco de non-woven 80 g/m² com alças compridas de 70 cm. Acabamento selado termicamente.

36 x 40 cm 50 250
F(1)

7527 Mito

Saco tote não tecido costurado com alças reforçadas. Ideal para sublimação. Alças de 70 cm.

36 x 40 cm 50 250
F(1), N(8), R

7126 Donet

Bolsa não tecida de 80 g/m² com alças robustas cortadas sob pressão e acabamento termo-selado.

34 x 43 cm 50 400
F(1)

7127 Trento

Sacos não tecidos sublimáveis de 80 g/m² com alças robustas cortadas sob pressão e acabamento termo-selado. Ideal para sublimação.

34 x 43 cm 20 400
F(1), N(8), R



COTTON TOUCH

7618 Miso

Saco ideal para sublimação em poliéster resistente e suave. Alças longas de 70 cm.

42 x 38 cm

10

100

F(6), N(8), R

SPECIAL FOR

SUBLIMATION



COTTON TOUCH

7569 Osak

Nécessaire, ideal para sublimação, em poliéster suave e com forro interior. Fecho de correr com puxador condizente.

22 x 14 x 6,5 cm

1/25

500

F(1), N(8), R



COTTON TOUCH

7180 Kanda

Mochila de cordão, ideal para sublimação, em poliéster macio e resistente.

42 x 34 cm

10

100

F(1), N(8), R

EATING & DRINKWARE



3986 **Adaya**

Caneca de vidro borossilicato fosco, especial para sublimação. Capacidade para 500 ml. Apresentação em caixa branca.



4148 **Puket**

Copo de vidro de borossilicato fosco, especial para sublimação. 330 ml de capacidade. Apresentação em caixa branca.



DISCOVER OUR NEW **SUBLIMATION** MUGS



3987 **Samui**

Caneca de cerâmica com acabamento brilhante, especial para sublimação. 700 ml de capacidade. Apresentação em caixa branca.



PREMIUM QUALITY

3999 **Lemon**

350 ml

3999 **Lemon**

Chávena de cerâmica de alta qualidade, especial para sublimação. Capacidade para 350 ml. Caixa individual não incluída. Apresentação em caixa de 36 unidades.

9,6 x Ø8,20 cm 1

36

4003 **Rambu**

MATT FINISH

4000 **Lima**4084 **Marang**

SUBLIMATION MUGS

350 ml

4003 **Rambu**

Caneca cerâmica de 350 ml com design em acabamento mate. Especial para sublimação. Apresentação em caixa branca.

9,6 x Ø8,20 cm 1 36



350 ml

4000 **Lima**

Caneca cerâmica de 350ml especial para sublimação. Apresentação em caixa branca.

9,6 x Ø8,20 cm 1 36



250 ml

4084 **Marang**

Caneca cerâmica de 250 ml especial para sublimação. Apresentação em caixa branca.

8,4 x Ø7,40 cm 1 48



MAGIC MUGS



350ml

4085 Okra

Caneca mágica em cerâmica com acabamento mate. Capacidade 350 ml. Verte líquido quente sobre a mesma e descobre o desenho escondido. Apresentação em caixa branca.

9,6 x Ø8,20 cm 1 36

F(1), Q



340ml

4060 Kaffir

Caneca cristal de 340 ml. Especial para sublimação. Apresentação em caixa individual eco.

9,5 x Ø8 cm 1 36

F(1), Q



350ml

4001 Mango

Caneca cerâmica de 350ml especial para sublimação. Interior e asa coloridos. Apresentação em caixa branca.

9,6 x Ø8,20 cm 1 36

Q



300ml

4002 Kumbo

Taça de cerâmica com design retro especial para sublimação. Capacidade de 300 ml. Apresentação em caixa branca.

8,5 x Ø8,70 cm 1 36

Q



0103

0131

0160

0105

01226

0102



0160

0105

0102



3996 **Walax**

Chávena de cerâmica com interior branco, ideal para impressão a laser. Capacidade para 350 ml. Apresentação em caixa branca.

9,6 x Ø8,20 cm 1 36

F(1), L2



03

60



242

114

02

SPECIAL FOR LASER ENGRAVING

WALAX & MACHA



3997 **Macha**

Chávena de cerâmica com interior colorido, ideal para impressão a laser. Capacidade para 350 ml.

9,6 x Ø8,20 cm 1 36

F(1), L2



03

31



60

242

226

SPECIAL FOR LASER ENGRAVING
NEWROIBO

NEW.

350 ml



226

03



60

05

02

3992 Roibo

Caneca de cerâmica, ideal para impressão a laser. Cor interior e exterior branca. Capacidade para 350 ml. Apresentação em caixa branca.

9,6 x Ø8,20 cm 1 36

F(1), L2

350 ml



251

260

4024 Zala

Caneca cerâmica de 350 ml com design de acabamento brilhante. Especial para gravação a laser. Apresentação em caixa branca.

9,6 x Ø8,20 cm 1 36

F(4), L2





300ml

4010 **Jack**

Caneca cerâmica de estilo retro com asa redonda. Capacidade de 300ml. Apresentação em caixa branca.

8,6 x Ø8,50 cm 1 36
F(4)



300ml

4009 **Nolo**

Taça de cerâmica com esmalte em cores de 300 ml. Apresentação em caixa branca.

10,4 x Ø8,50 cm 1 36
F(4)



350ml

4008 **Akebia**

Caneca cerâmica de 350ml. Interior e colher coloridos. Apresentação em caixa branca.

10,5 x Ø8,30 cm 1 36
F(4)





370ml

4005 **Yuca**

Caneca cerâmica de 370ml. Apresentação em caixa branca.

9,8 x Ø8,20 cm 1 36
F(4)



370ml

4006 **Papaya**

Caneca cerâmica colorida de 370ml. Apresentação em caixa branca.

9,8 x Ø8,20 cm 1 36
F(4)

350ml

4007 **Palta**

Caneca quadro de 350 ml. Inclui giz. Apresentação em caixa branca.

9,6 x Ø8,20 cm 1 36
F(1)





4057 **Sacha**

Copo reutilizável com capacidade de 380 ml. Corpo em PP com cobertura em cortiça natural. Apresentação em caixa individual eco.

8,5 x Ø11 cm 1 40
F(1), L1



NEW.
COLOR



01 02



4013 **Rosella**

Caneca de cerâmica com acabamento fosco com fundo de cortiça natural. 420 ml de capacidade. Apresentação em caixa de cartão kraft.

11 x Ø9 cm 1 36
F(1)



4012 **Berry**

Caneca cerâmica com acabamento mate e tampa de bambu natural. Capacidade de 370ml. Apresentação em caixa de cartão kraft.

10,5 x Ø8,20 cm 1 36
F(1), L2



MATT FINISH

+ antibacterial

ISO 22196



4064 Gosto

Copo descartável anti-bactérias com tampa e mosquetão para transportar. 220 ml de capacidade.

9 x Ø3,70 cm 1/50 200

D(4), W



4062 Bustan

Copo reutilizável de PLA com tampa enroscável e capacidade 450 ml.

13,5 x Ø9,40 cm 1 50

F(1)



4063 Parcha

Caneca reutilizável de PLA com 350 ml de capacidade.

8,8 x Ø7,90 cm 1/50 100

F(4)



4065 Yobo

Fiambreira produzida em PLA com elástico ajustável em silicone. Inclui garfo, colher e faca. Capacidade 1 L.

19,1 x 7,4 x 11,8 cm 1 40

E(1), W



SUBLIMATION



380ml

4014 **Damasco**

Caneca metálica estilo retro. Especial para sublimação. Capacidade 380ml. Apresentação em caixa branca.

7,9 x Ø8,80 cm 1 48

L2, Q



0101

0301

6001



0501

5601

0201

380ml

4015 **Anon**

Caneca metálica de 380ml em estilo retro. Apresentação em caixa branca.

7,9 x Ø8,90 cm 1 48

F(4), L1



METAL MUGS



05

02

60

251

226

290ml

4083 **Kiwan**

Caneca metálica de parede dupla com exterior de cor. Capacidade 290 ml. Apresentação em caixa branca.

9 x Ø7,70 cm 1 50

F(1), L1

1,2 L

4069 **Brena**

Lancheira de aço inoxidável com tampa de bambu e faixa de segurança de poliéster. Capacidade 1,2L. Apresentação em caixa de design ecológico.

19,6 x 7 x 13,6 cm 1

20

F(1), L2

**NEW.**

450 ml

3985 **Teide**

Caneca em aço inoxidável 304 com puxadores rebatíveis. Capacidade de 450 ml. Apresentação em caixa branca.

8,2 x Ø9,20 cm 1

50

F(1), L2



NEW
TEIDE



03

60

05

226

02

230 ml

4082 **Guaya**

Caneca metálica de parede dupla com asa de mosquetão. Capacidade 230 ml. Apresentação em caixa branca.

8 x Ø7 cm 1

50

F(1), L2





4066 **Korlan**

Lancheira de aço inoxidável com tampa de bambu e faixa de segurança de poliéster. Capacidade 800 ml. Apresentação em caixa de design ecológico.

15,8 x 6,1 x 11,9 cm



F(1), L2



4103 **Daikon**

Merendeira de aço inoxidável 304 com tampa de bambú. Sistema com fecho de fivela lateral. Capacidade 1L. Apresentação em caixa design eco.

19,4 x 6,8 x 13,1 cm



E(1), L2



4117 **Colmer**

Kit de talheres de bambú natural apresentados em capa de algodão com cordão de fechamento atômico. Inclui garfo, faca e colher.

6,5 x 1 x 22 cm



F(1), B(4), L1, N(8)





4077 **Malow**

Conjunto de 2 canudos de aço inox 304 com manga de algodão. Inclui escova de limpeza.

25,5 x 6 cm

1/100  400

 E(1), L1, N(8)



01

02

4068 **Ladas**

Canudo extensível reutilizável em aço inox 304, com boquilha de silicone. Inclui escova de limpeza e estojo com mosquetão para transporte.

10,5 x Ø1,60 cm  1/100  500

 E(1), L1



CUTLERY SET

4030 **Belver**

Conjunto de talheres de aço inoxidável apresentados num prático estojo de neoprene. Inclui garfo, faca e colher.

21 x 6 cm

 1  100

 F(1), L2

1L

4107 **Dalia**

Merendeira de vidro com tampa hermética. Capacidade de 1L. Apresentação em caixa de design.

 20,6 x 7 x 15,6 cm  1

 20

 F(1)



GLASS

LUNCH BOX



BAMBOO

900.ml

4061 **Sambal**

Lancheira de vidro com tampa de bambu e elástico em silicone. Capacidade 900 ml. Apresentação em caixa individual eco.

 20 x 6 x 15 cm  1

 20

 E(1), L2

RPET COOLER BAGS



○
●
MARLOX

BISMAR
○
●



243

255

RECYCLED
PET

7609 Marlox

Geladeira XL de poliéster reciclado RPET com design vigoré. Duplo compartimento e bolso frontal. Interior isotérmico. Inclui correia de transporte ajustável.

30 x 25 x 20 cm 1 25

F(1), N(8)



243

255

RECYCLED
PET

7608 Bismar

Geladeira de poliéster reciclada RPET com design vigoré. Bolso frontal e interior isotérmico. Inclui correia de transporte ajustável.

25 x 15,5 x 15,5 cm 1 60

F(1), N(8)



4133 Vertus

Copo de vidro duplo em vidro borossilicato e tampa de bambu. Capacidade para 350 ml. Apresentação em caixa de design ecológico.

13,6 x Ø8,90 cm 1 40

F(1), L2

GLASS & BAMBOO



3998 Indal

Chávena de vidro duplo em vidro borossilicato com tampa em bambu. Capacidade para 280 ml. Apresentação em caixa de design ecológico.

9,6 x Ø8,80 cm 1 40

F(1), L2



4081 Coco

Caneca cristal com tampa e colher em bambu. Capacidade 420 ml. Apresentação em caixa individual eco.

9,5 x Ø8 cm 1 36

F(1), C(4), L2

FOR COFFEE LOVERS

BOROSILICATE
GLASSDOUBLE
WALL

90ml

4132 Capsul

Conjunto de 2 copos de vidro duplo em vidro borossilicato. Capacidade para 90 ml. Apresentação em caixa de design ecológico.

6,6 x Ø6,70 cm 1/12 24

F(1)



NEW.

GLASS | BAMBOO

NEW BOTTLES

05

60

226



BOROSILICATE
GLASS

4202 **Dalby**

Copo de vidro de borossilicato com efeito fosco gradiente de cor. Tampa e palha em bambu. Capacidade para 350 ml. Apresentação em caixa de design ecológico.

14 x Ø7,50 cm 1 30

F(1), L2



BOROSILICATE
GLASS

BAMBOO

NATURAL
CORK

450 ml

4138 **Iroko**

Copo alto em vidro borossilicato com capa em cortiça natural. Tampa e palha em bambu. Capacidade para 450 ml. Apresentação em caixa de design ecológico.

18 x Ø6,80 cm 1 30

F(1), G(1), N(8)



GLASS CORK

VACUUM FLASK



NEW.



4211 Coiba

Garrafa térmica de aço inoxidável 304 com parede dupla e detalhes em bambu. Tampa com alça de dupla função, como suporte móvel. Capacidade para 450 ml. Apresentação em caixa de design ecológico.

 22 x Ø7 cm

 1

 50

 F(1), L2, W

NEW.



4206 **Cedro**

Termo com parede dupla em aço inoxidável 304 e bambu com filtro de chá. Termômetro digital tátil na tampa. Capacidade de 480 ml. Bateria de botão incluída. Apresentação em caixa de design ecológico.

23,5 x Ø6,50 cm 1 30

F(1), L2, W



BAMBOO THERMOS



4032 **Kinata**

Bidão em aço inoxidável de parede dupla. Parede exterior em bambu natural. Capacidade 500 ml. Apresentação em caixa de papel kraft.

24,5 x Ø6,90 cm 1 30

F(1), L2, W



BAMBOO & STAINLESS STEEL

4097 **Pana**4100 **Sotos**4035 **Fengi**4033 **Yaba**

4097 **Pana**

Caneca de parede dupla de aço inoxidável com exterior de bambu natural. Inclui tampa. Capacidade de 340 ml. Apresentado em caixa de design ecológico.

10,8 x Ø8,20 cm 1 50

F(1), L2



4100 **Sotos**

Garrafa de aço inoxidável 304 com rolha de bambu. Inclui correia de transporte. Capacidade 600 ml. Apresentado em caixa de desenho.

22 x Ø6,30 cm 1 50

F(1), L2, L3, W



4035 **Fengi**

Termo em aço 304, com parede dupla e bambu. Capacidade 420 ml. Inclui asa de transporte. Apresentação em caixa individual kraft.

25,5 x Ø6 cm 1 25

F(1), L2

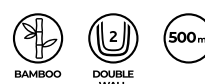

4033 **Yaba**

Copo de aço inoxidável 304 com parede externa em bambu natural. Capacidade 500ml. Apresentação em caixa de papel kraft.

17,5 x Ø8,20 cm 1 50

F(1), L2, W

NEW.



BAMBOO

BOROSILICATE
GLASSDOUBLE
WALL

420ml

4203 **Saoko**

Frasco de vidro de borossilicato com parede dupla e tampa de bambu. Filtro para chá incluído. 420 ml de capacidade. Apresentação em caixa de design ecológico.

23,9 x Ø7 cm

1

20

F(1), L2, W

FOR TEA LOVERS



BAMBOO



450ml

4020 **Trilby**

Recipiente em vidro de 450 ml com tampa em bambu e cinta de transporte em acabamento natural. Apresentação em caixa de design.

19,7 x Ø6,40 cm

1

50

F(1), L2, W



4136 **Lawas**

Garrafa de vidro com capa em cortiça. Tampa de bambu com alça prática para transporte. Capacidade para 500 ml. Apresentação em caixa de design ecológico.

22,5 x Ø6,40 cm 1 30

F(1), G(1), N(8)



GLASS BOTTLES

4137 **Sibu**

Garrafa de vidro com capa de juta falsa e tampa em bambu com alça prática para transporte. Capacidade para 500 ml. Apresentação em caixa de design ecológico.

22,5 x Ø6,40 cm 1 30

F(1), G(1), N(8)



01 60 05 226 02

4055 **Nagami**

Garrafa de vidro com tampa de bambu e manga colorida de silicone. Capacidade 540ml. Apresentação em caixa individual.

23,1 x Ø6,70 cm 1 30

G(1), L2





500ml

4040 **Camu**

Recipiente em vidro de 500 ml. Caixa e cinta de transporte coloridas. Apresentação em caixa de design.

22 x Ø6,70 cm 1 40

F(1), G(1), N(8), L2, Q

SUBLIMATION



600ml

4098 **Kaster**

Garrafa de vidro de 600 ml. Inclui estojo de cor com pega de transporte. Apresentação em caixa de desenho.

16,2 x Ø8,80 cm 1 40

F(1), N(8), L2, R



CHOOSE YOUR FAVOURITE COLOUR



00

31

60



05

226

02

650 ml

4099 **Sandi**

Garrafa de vidro com corpo de cor translúcida. Tampa de aço inoxidável. Capacidade de 650 ml. Apresentação em caixa de desenho.

26 x Ø7,10 cm

1

30

F(1), L2, W



GLASS BOTTLES



00

03

31

60



40

05

226

02

500 ml

4037 **Alfe**

Garrafa de vidro com corpo colorido. Capacidade 500 ml. Inclui correia de transporte. Apresentação em caixa individual.

22 x Ø6,30 cm

1

50

F(1), L2, W

CHOOSE YOUR SIZE, CHOOSE YOUR FINISH.

MATT & SHINY

4093 Yisel

4149 Kemy



SAME DESIGN



DOUBLE WALL

500ml



4149 Kemy

Garrafa térmica de parede dupla em aço inoxidável 304. Capacidade para 500 ml. Apresentação em caixa de design.

23,5 x Ø6,80 cm 1 30

F(1), L2, L3, W



01 165 60 43 271 02



DOUBLE WALL

750ml



4093 Yisel

Garrafa grande térmica de aço 304 com dupla capa e isolamento de cobre a vácuo. Capacidade de 1 L.

28,5 x Ø7,30 cm 1 20

F(1), L2

DIFFERENT SIZE



4122 **Balax**

Garrafa térmica de parede dupla em aço inoxidável 304. Parede dupla com isolamento a vácuo de cobre. 550 ml de capacidade. Apresentação em caixa de design.

22,5 x Ø7,40 cm 1 30

F(1), L2, L3, Q



NEW.
COLOR

SUBLIMATION



01



60



05



02



251



281



260

BALAX



SUBLIMATION



01

03

60



05

226

02

800ml

4144 **Magun**

Garrafa de aço inoxidável 304 em acabamento robusto.
Capacidade para 800 ml. Apresentação em caixa de design.

22,5 x Ø7,40 cm  1  40

 F(1), L2, L3, Q

LEBAUHAUS



DOUBLE WALL



500ml



4126 **Fancy**

Garrafa térmica em aço inoxidável 304. Parede dupla com isolamento de cobre. Capacidade 500ml. Apresentação em caixa própria.

26,3 x Ø7 cm

1

30

F(1), L2, L3, W

SUBLIMATION



01



60



05



260



251



02





SUBLIMATION



01 60 05 02

DOUBLE
WALL

600ml

4139 **Torke**

Garrafa térmica de parede dupla em aço inoxidável 304. Capacidade para 600 ml. Apresentação em caixa de design.

26 x Ø6,90 cm



F(1), L2, L3

DOUBLE
WALL

500ml

4059 **Copo**

Garrafa térmica de aço inoxidável 304 com parede dupla especial para sublimação. Capacidade 500 ml. Apresentado em caixa de desenho.

25,5 x Ø7,30 cm



L2, L3, Q

**NEW.**DOUBLE
WALL

850ml

4145 **Beluga**

Garrafa de aço inoxidável 304 com parede dupla. 850 ml de capacidade. Apresentação em caixa de design.

30,5 x Ø8 cm



F(1), L2, L3, W



01

251

02



DOUBLE WALL



NATURAL CORK



460ml



4056 **Tayox**

Termos de parede dupla de aço 304 com infusor de chá e base de cortiça. Capacidade de 460 ml. Apresentação em caixa de desenho.

24,5 x Ø6,40 cm



F(1), L2

TAYOX

DOUBLE WALL | 460ML.



CORK & STAINLESS STEEL



01

251

02



DOUBLE WALL



NATURAL CORK



520ml



4105 **Kale**

Garrafa grande térmica de aço inoxidável 304 dupla parede e base de isopor. Capacidade 520 ml. Apresentação em caixa design.

27 x Ø7,10 cm



F(1), L2

SUBLIMATION

DOUBLE WALL | 500ML.

NEW TISSET



01

60

05

242

226

251

02



DOUBLE WALL



500ml

NEW.



4201 Tiset

Frasco de parede dupla em aço inoxidável 304 com tampa de bambu. Capacidade para 500 ml. Apresentação em caixa de design.

21 x Ø7,30 cm 1 30

F(1), L2, L3, W, Q



SUBLIMATION



01

60

05

251



BAMBOO



620ml

4039 Boina

Recipiente em aço inoxidável 304 e bambu. Especial para marcar em sublimação. Capacidade de 620 ml. Apresentação em caixa de design.

21 x Ø7,30 cm 1 50

F(1), L2, Q



SUBLIMATION



01 60 05 251 02



500ml

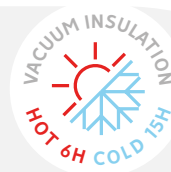

4123 Salvia

Frasco de aço inoxidável 304 de parede dupla. Acabamento brilhante. Capacidade de 500 ml.

24,5 x Ø6,90 cm 1 30

F(1), L2, L3



SUBLIMATION



01 251 02



450ml

4106 Palmer

Garrafa térmica de aço inoxidável 304 dupla parede. Botão de abertura com feche de segurança. Capacidade 450 ml.

22 x Ø6,50 cm 1 30

F(1), L2



450ml



60 05 251

4135 Dango

Recipiente térmico com revestimento duplo em aço inoxidável 304, perfeito para transportar alimentos. Tampa dupla com colher dobrável de aço inoxidável incluída. Capacidade para 450 ml. Apresentação em caixa de design.

15,7 x Ø9,50 cm 1 20

F(1), L2, L3



06

55

56

02

DOUBLE
WALL

450ml

4134 **Okele**

Copo térmico duplo em aço inoxidável 304. Tampa prática de enroscar à prova de respingos. Capacidade para 450 ml. Apresentação em caixa de design ecológico.

14,6 x Ø8,90 cm 1 40

F(1), L2, L3

NON-SLIP BASE



STAINLESS STEEL | DOUBLE WALL

THERMO
CUP

01

31

60

05

226

251

02

290ml

4029 **Milu**

Copo em aço inoxidável de 290 ml com tampa em PP. Apresentação em caixa de design.

14,4 x Ø7,30 cm 1 50

F(1), L2, L3, W



01

60

05

251

02

310ml

4028 **Salak**

Copo em aço inoxidável de 310 ml com tampa em PP. Apresentação em caixa de design.

16,7 x Ø7,20 cm 1 50

F(1), L2, W

BOTTLES STAINLESS STEEL



4125 **Tarek**



4042 **Alpinia**



4200 **Selby**

SUBIMATION



01 03 31 60



40 05 226 02



01 60 05 251 02



4125 **Tarek**

Garrafa em aço inoxidável 304 com acabamento mate. Capacidade 790ml. Apresentação em caixa .

25,7 x 07,40 cm 1 50

F(1), L2, L3, W



4042 **Alpinia**

Recipiente em aço inoxidável 304. Capacidade de 700ml. Apresentação em caixa de design.

25,5 x 07,10 cm 1 50

F(1), L2, L3, W



4200 **Selby**

Garrafa de aço inoxidável 304, especial para sublimação. 700 ml de capacidade. Apresentação em caixa de design.

25,7 x 07,10 cm 1 40

L2, L3, Q



01 60 05 226 02

630 ml

4011 **Pita**

Garrafa em aço inoxidável 304. Capacidade 630ml. Design de cor sólida com acabamento mate.

25,5 x Ø7,10 cm 1 30

F(1), L2, L3, W



01 60 05 02

850 ml

4034 **Alke**

Garrafa em aço 304 com corpo em 2 tons e acabamento mate. Tampa com asa flexível de borracha. Capacidade 850 ml. Apresentação em caixa individual.

24,7 x Ø7,50 cm 1 30

F(1), L2, L3



60

05

226

251

02



NEW.

4212 **Lewik**

Frasco em alumínio reciclado com tampa correspondente e alça de transporte. 600 ml de capacidade. Apresentação em caixa de design ecológico.

22,5 x Ø6,60 cm 1 50

F(1), L2, L3, W

RECYCLED ALUMINIUM

RECYCLED ALUMINIUM



01

60

05

226

251

02

**NEW.**

4214 Renko

Frasco em alumínio reciclado com mosquetão correspondente. Capacidade de 400 ml. Apresentação em caixa de design ecológico.

17,5 x Ø6,60 cm 1 50

F(1), L2, L3, W

**NEW.**

4213 Kisko

Frasco em alumínio reciclado. 550 ml de capacidade. Apresentação em caixa de design ecológico.

23,5 x Ø6,60 cm 1 50

F(1), L2, L3, W



01

60

05

226

251

02

ALUMINIUM & BAMBOO

NEWBOTTLES

NEW.

4205 Broly

NEW.

4204 Gelda

4205 **Broly**

Frasco de alumínio com mosquetão e tampa de bambu. 800 ml de capacidade. Apresentação em caixa de design ecológico.

24,3 x Ø7,30 cm 1 40

F(1), L2, L3, W

4204 **Gelda**

Frasco de alumínio com mosquetão e tampa de bambu. Capacidade de 400 ml. Apresentação em caixa de design ecológico.

17,1 x Ø6,60 cm 1 50

F(1), L2, L3, W

SUBLIMATION



01 60 05 226 02

4049 **Baobab** 800ml

Recipiente em alumínio com mosquetão. Capacidade de 800 ml. Apresentação em caixa de design.

24,6 x Ø7,30 cm 1 50

F(1), L2, L3, W, Q

4045 **Athletic**4049 **Baobab**4004 **Yaca**

SUBLIMATION



01 60 05 226 251 02

4045 **Athletic** 400ml

Recipiente em alumínio com mosquetão. Capacidade de 400ml. Apresentação em caixa de design.

17,5 x Ø6,60 cm 1 50

F(1), L2, Q



01 03 60 05 226 02

4004 **Yaca** 330ml

Garrafa em alumínio com mosquetão na cor correspondente. Capacidade 330ml. Apresentação em caixa de design.

15 x Ø6,60 cm 1/50 100

F(1), L2, L3



01 03 60 05



226 251 02

680 ml

4058 **Chito**

Bidão de alumínio com corpo em acabamento sólido. Capacidade 680 ml. Tampão com boquilha retrátil e asa para transporte. Apresentação em caixa individual.

22,1 x Ø7,30 cm 1 50

F(1), L2



00 31 60 05 226 02



4067 **Valsan**

Garrafa RPET com corpo em cor translúcida. Capacidade 600 ml. Inclui correia de transporte. Apresentação em caixa de design ecológico.

21,5 x Ø6,50 cm 1 50

F(1), L2

100%
RPET



00

60

05

226



4041 Eddo

Recipiente de 700 ml com acabamento em AS transparente. Tampa e base em aço inoxidável. Apresentação em caixa de design.

26,5 x Ø7,10 cm 1 30

F(1), L2, W



01

03

60



05

226

02



4038 Kinkan

Bidão em tritan com corpo translúcido. Tampa a combinar com asa de transporte integrada. Capacidade 650 ml. Apresentação em caixa individual.

25,7 x Ø6,70 cm 1 50

F(1), W

CHOOSE YOUR BOTTLE



01

60

05

226

02



4044 Aloe

Recipiente em tritan 600 ml. Tampa com cinta de transporte colorida. Apresentação em caixa de design.

22,5 x Ø6,60 cm 1 50

F(1), W



SOFTFLASK



01 05

4104 Trail

Garrafa grande dobrável realizada em TPU flexível. Inclui alça de transporte. Ideal para eventos esportivos. Capacidade 500 ml.

25 x 9 cm 1/50 400

F(1)



01 05

4119 Track

Copo dobrável ideal para eventos esportivos realizado em TPU flexível. Capacidade 230 ml.

10,7 x Ø6,80 cm 1/50 600

F(1)



01 03 60 05 226



4086 Mandy

Bidão de PET flexível em forma de camisola. Tampa de segurança e mosquetão para transporte. Capacidade 470 ml.

17 x 25,5 x 3,3 cm 1/50 400

E(1)



01 03 31 60 05 226 02



520ml

4046 **Running**

Recipiente desportivo em PE. Capacidade de 520ml.

19,5 x Ø6,50 cm 1/10 100

F(1)



SPORT BOTTLES



01 03 31 60 05 226 02



840ml

4036 **Kumat**

Bidão desportivo em PE com capacidade de 840 ml.

23,5 x Ø7,50 cm 1/10 50

F(1)



01 03 31 60 05 226 02



620ml

4047 **Biking**

Recipiente desportivo em PE com ampla superfície de marcação. Capacidade de 620 ml.

20,5 x Ø7,50 cm 1/10 100

F(1)



**HOME, GIFTS
& PREMIUM**



NEW.



NEW.



HEMP FABRIC

200 g/m²9139 **Bost**

Avental de sarja longa em poliéster reciclado e algodão. Alça de pescoço com fecho ajustável. Correias de amarração laterais. Dois bolsos na frente.

70 x 90 cm

1

50

E(4), N(8)

200 g/m²9140 **Maule**

Avental em tecido cânhamo (200 g/m²), com bolso frontal. Tamanho único ajustável.

65 x 90 cm

10

100

E(4), N(8)

NEW.



9142 **Nopal**

Toalha de cozinha em 100% algodão (180 g/m²).

40 x 65 cm

10

200

F(1), N(8), O, P



NEW.



9143 **Peyot**

Tapete de mesa em 100% algodão Fairtrade (140 g/m²).

45 x 30 cm

10

300

F(1), N(8), O, P

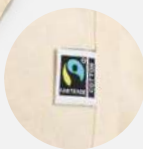

FAIRTRADE COTTON



9141 **Taber**

Avental em algodão Fairtrade 100% com bolso frontal. Tamanho único ajustável.

65 x 90 cm

10

100

E(4), N(8), P



RECYCLED COTTON



226



29



60



02



05

RECYCLED
COTTON

9136 Arola

Avental 100% algodão reciclado em acabamento mosqueado. Bolso frontal. Tamanho único ajustável para todos.

93 x 65 cm

10

100

F(4), N(8), P

ORGANIC
COTTON

9135 Oliver

Avental 100% algodão orgânico com bolso frontal. Tamanho único ajustável para todos.

93 x 65 cm

10

100

F(4), N(8), P

SMOOTH SIDE
FOR MARKINGRECYCLED
COTTON

9144 Forset

Luva de cozinha em 100% algodão reciclado, com um lado plano ideal para marcação e uma alça de suspensão.

18,5 x 26 cm

1/50

200

E(1), N(8)

SMOOTH SIDE
FOR MARKINGORGANIC
COTTON

9138 Mauro

Luvas 100% de algodão orgânico. Uma cara lisa ideal para marcação e fita para pendurar.

30,5 x 19 cm

1/25

200

E(1), N(8)



9128 Ramsay



9129 Ducasse



01 60 05 02

9128 Ramsay

Avental comprido em sarja.
 · Fita de pescoço no mesmo tom.
 · Fitas laterais para laço.

65 x 90 cm 50 100
 Consult



01 03 31 60 40 05 114 02

9129 Ducasse

Avental comprido em popelina.
 · Fita de pescoço no mesmo tom.
 · Fitas laterais para laço.
 · Dois bolsos frontais, um interior e outro grande sobreposto.

65 x 90 cm 10 100
 Consult



01 03 60 40



05 226 02



01 60 05

9133 Jamie

Conjunto de avental e chapéu infantil. Em tecido não tecido de 80 g / m². Tamanho único ajustável. Bolso avental 17x17cm.

APRON: 59,5 x 49 cm HAT: 30 x 20 cm
 10 300 F(1)

9130 Keller

Avental não-tecido colorido com bolso central. Tamanho único ajustável. Bolso 22x17cm.

50 x 73 cm 10 200
 F(1)





9134 Roger

Luva de cozinha em poliéster. Acabadona na cor branca, com bordas e fita em cores para pendurar.

19 x 30,5 cm 1/50 200
E(1), N(8), R



SPECIAL FOR SUBLIMATION



SMOOTH SIDE
FOR MARKING



9137 Eneko

Kit de cozinha composta por pegador e luva em suave algodão/poliéster. Uma cara lisa ideal para marcação e fita para pendurar.

30,5 x 19 cm 1/10 100
E(1), N(8)

KITCHEN GLOVES



SMOOTH SIDE
FOR MARKING

9132 Roca

Luva de cozinha em algodão/poliéster suave com parte lisa para marcação.

19 x 30,5 cm 25 200
E(1), N(8)



NEW.



BAMBOO



4 147 **Baru**

Espátula de cozinha em bambu.

6 x 30 cm

1/50

200

C(4), L1



NEW.

NEW KITCHEN ACCESSORIES



BAMBOO



4 146 **Nori**

Colher de cozinha em bambu.

6 x 30 cm

1/50

200

C(4), L1



BAMBOO



5 KG



3028 **Rabil**

Balança de cozinha digital com revestimento frontal de bambú natural. Capacidade máxima de 5kg. Funciona com pilha incluso. Apresentação em caixa design eco.

15 x 1,6 x 21,5 cm

1/10

20

E(1), L2, W



4116 **Angus**4114 **Devon**4115 **Boran**

BAMBOO

4114 **Devon**

Tábua de cortar de bambú natural.
Talhado para pendurar e de fácil manuseio.
Apresentação em caixa eco.

15,3 x 1 x 20 cm 1 50

E(1), L2



BAMBOO

4115 **Boran**

Tábua de cortar de madeira com alça para
fácil manuseio e corda para pendurar.

40 x 1 x 13,5 cm 1 30

E(1), L2



BAMBOO

4116 **Angus**

Tábua de cortar de bambú natural com
perfil coleta líquidos. Apresentação em caixa
eco.

30 x 1,2 x 20 cm 1 20

E(1), L2

CUTTING BOARDS



4102 **Comte**

Conjunto de queijos com 4 utensílios de aço inoxidável e cabo de madeira. Apresentado numa prática caixa de madeira com uma tábua de corte na parte superior. Apresentação em caixa branca.

3,6 x Ø20 cm
 1
 10
 E(1), L2

WOOD & STAINLESS STEEL

FOR CHEESE LOVERS



4101 **Edam**

Conjunto para queijos com 4 utensílios de aço inoxidável e cabo de madeira. Apresentado numa elegante mala com interior almofadado.

21,5 x 3,4 x 17,4 cm
 1/10
 40
 F(1), L1



4140 **Pinea**

Conjunto de 4 porta-copos em madeira de pinheiro natural. Apresentação com cordão de juta natural em caixa de design ecológico.

 10 x 4,5 cm

 1/25

 50

 E(1), L2

WOOD & CORK



4113 **Algor**

kit de 4 porta-copos de bambú natural. Apresentação em caixa eco.

 11,6 x 3,6 x 11,6 cm

 1

 20

 E(1), L2



4087 **Chala**

Base para copos em cortiça natural

 Ø10 cm

 10/500  1000

 D(1), L1, W

NEW WINE COOLERS



NEW.



NEW.

VELCRO FASTENER



57

55

02

7082 Frost

Luva do refrigerador de garrafa em poliéster, com tiras elásticas para um ajuste perfeito.

15,5 x 22,5 cm 1/25 50

F(1)



7081 Moke

Luva do resfriador de frascos em PET, com fecho em velcro ajustável.

40 x 18 cm 1/25 50

F(1)



4112 Malbec

kit de vinho com acessórios de aço inoxidável, saca rolhas com cortadores de cápsula, coleta gotas, Tampa e dispensador. Apresentado em caixa de metal com interior de acolchoado.

18 x 4 x 11 cm  1  20
 G(1), L2





WINE LOVERS



4075 Merlot

Saca-rolhas de estilo clássico em aço inoxidável com duas posições. Apresentação em caixa branca.

12 x 2,1 x 1,3 cm  1/10  200
 D(1), L1



01 60 05 02



4118 Garnac



Saca rolhas de estilo clássico em aço inoxidável. Com cortador de cápsulas e abridor. Apresentação em caixa branca

11 x 1,2 x 2,2 cm  1/10  200
 D(1)



4076 Syrah

Saca-rolhas metálico com forma de garrafa. Plástico PS. Apresentação em caixa branca.

12 x Ø2,50 cm  1/50  200
 D(1)





NATURAL CORK

4091 **Venet**

Conjunto para vinho com acessórios de aço inoxidável, saca-rolhas de 2 tempos com cortador de cápsulas, contagotas e doseador. Apresentado numa caixa de cortiça natural com interior almofadado.

4,2 x Ø14,90 cm 1 20

F(1), L2



4 ACCESSORIES



WINESET

CORK | WOOD



BAMBOO

4129 **Tintos**

Conjunto para vinho com acessórios em aço inoxidável e bambu. Saca-rolhas com lâmina dobrável, rolha protetora e anel antigotejamento. Apresentação em caixa de bambu de design ecológico com forro acolchoado.

16 x 4,8 x 10 cm 1 20

E(1), L2





4078 Shake

Abre cápsulas fabricado em madeira natural com interior em aço inox. Inclui orifício superior para pendurar.

17,9 x 4,1 cm 1/50 100

D(4), L1, W



4111 Colins

Abridor de desenho compacto realizado em madeira natural com interior de aço inoxidável e troquel superior para enganchar.

10,5 x 1 x 4 cm 1/50 200

D(4), L1



4090 Roden

Abridor de garrafas em aço inoxidável com cabo de madeira natural.

4 x 14,3 x 2,1 cm 1/50 200

D(4), L1, W



4088 Sherry

Abre cápsulas magnético em bambu com função de base para copo.

1,1 x Ø6 cm 1/50 500

D(4), L1, W



580 ml

3993 **Larius**

Conjunto para cocktail em aço inoxidável 304. Acessórios incluídos: medidor, misturador de 580 ml, passador e agitador. Inclui bolsa de transporte. Apresentação em caixa de design ecológico.

29,5 x Ø8,70 cm 1 20

F(1), L2



COCKTAIL SET | STAINLESS STEEL

LARIUS

MAKE YOUR BEST COCKTAIL

MADE IN STAINLESS STEEL



700 ml

3994 **Daniel**

Misturador de cocktail em aço inoxidável com tampa à prova de respingos e tampa para verter. Capacidade para 700 ml. Apresentação em caixa de design ecológico.

16,1 x Ø8,80 cm 1 40

F(1), L2

3995 **Cardu**

Medidor duplo em aço inoxidável. Capacidade para 15 e 30 ml. Apresentação em caixa branca.

6,9 x Ø3,90 cm 1/50 200

F(1), L1



175 ml

4141 **Walker**

Garrafa de bolso em aço inoxidável e tampa à prova de gotejamento. Capacidade para 175 ml. Apresentação em caixa de design ecológico.

9,3 x 11,2 x 2,1 cm 1/50 100

F(1), L2

NEW.

1040 **Viza**

Conjunto de bowling de madeira com 10 pinos e 2 bolas. Bolsa de algodão fácil de transportar incluída. Apresentação em caixa de design ecológico.

32 x 34 cm

1

8

G(1)

WOODEN GAMES

1014 **Galvy**

Conjunto de 4 jogos de habilidade: mikado, xadrez, damas e dominó. Apresentado numa caixa com tampa deslizante com função de tábua no interior.

16,6 x 3 x 16,5 cm

1

50

D(2), L2, W





1013 **Domis**

Jogo de dominó feito de madeira. 28 peças apresentadas numa caixa com tampa deslizante.

 14,6 x 3 x 5 cm  1/50  100

 D(2), L2, W



1016 **Brisca**

Conjunto de 2 jogos de tabuleiro: baralho de cartas e dados franceses. Apresentado numa caixa de madeira com dois compartimentos e tampa deslizante.

 10 x 2,5 x 9,1 cm  1/50  100

 D(4), L2, W



NEW NAIPES



1028 **Naibe**

Baralho de cartas francês em cartão reciclado. 54 cartões incluídos. Apresentação em caixa de design ecológico.

 9 x 2 x 6 cm  1/100  200

 D(1)





NEW.

1035 **Pensy**

Jogo do galo de madeira. Inclui 10 peças apresentadas numa bolsa de algodão natural.

13 x 12 cm

1/10

500

G(1)

1011 **Triwa**

Jogo de tabuleiro 3 em fila feito de madeira. 9 blocos apresentados numa caixa com tampa deslizante.

7,5 x 3,2 x 7,5 cm

1/50

200

D(4), L2, W

1010 **Ryman**

Jogo de habilidade composto por 45 blocos rectangulares, apresentados num saco de algodão com cordões de cordões.

5,7 x 16,5 x 5,7 cm

1

50

G(1), N(8)

1009 **Rocks**

Conjunto de 3 jogos de perícia em madeira natural. Apresentado numa caixa de madeira com compartimentos e tampa deslizante.

16,5 x 6 x 6,4 cm

1

50

D(4), L2, W



NEW.

1041 **Cubik**

Jogo de habilidades, disponível em 24 modelos diferentes.

4 x 4 x 4 cm

24

576

C(1)

CLASSIC GAMES

0111 **Leis**

Quebra-cabeça Tangram em madeira natural com 7 peças coloridas.

10,3 x 10,3 cm

1/100

400

E(1), L2



01

29

03

60

05

226

0112 **Rosko**

Ioiô de madeira natural com cordão de 75 cm.

2,8 x Ø5,50 cm

1/50

400

C(4), W, L1

8069 Resol

Kit infantil para colorir. Inlui blocos com vários desenhos, 6 lápis de cor, apontadores e borrachas. Prática alça de transporte.

20 x 21 x 1,6 cm 1/40 80

D(1)

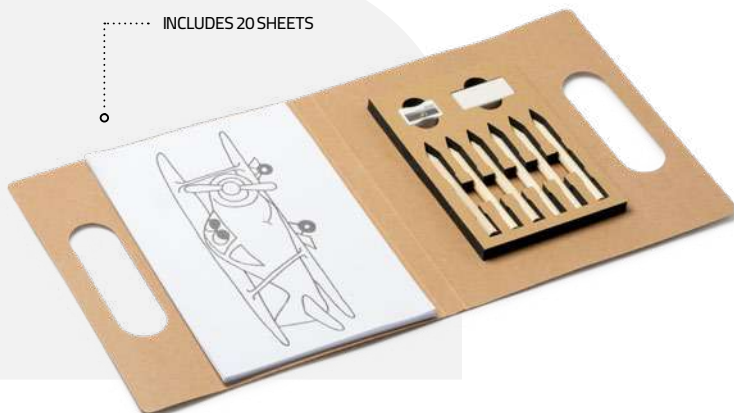

INCLUDES 20 SHEETS

PENCIL SET



03

31

60

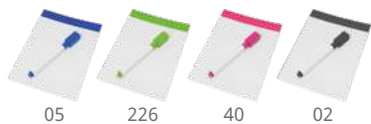

05

226

40

02

8047 Lilian

Marcador com tampa magnética em várias cores. Marcador de tinta preta com borracha incluída.

10,5 x 15 cm 1/25 200

D(4)



8077 Pyrus

Kit infantil para colorir. Inlui blocos com vários tipos de desenhos, 12 lápis de cor.

10 x 1 x 9,5 cm 1/50 200

C(4)

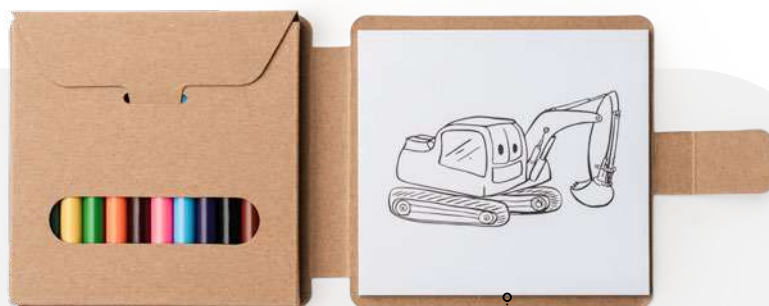

36 SHEETS



8049 Tilos

Conjunto infantil para colorir. Inclui bloco com desenhos, 6 lápis de cor e afia lápis. Apresentação em caixa de cartão reciclado.

7,4 x 1,5 x 9 cm 1/50 400

C(4), W

COLOURING DRAWINGS



9131 Pachu

Avental infantil em não-tecido com desenho para colorir. Inclui 5 lápis de cera em várias cores. Tamanho único ajustável.

43 x 43 cm

1/50

200

F(1)



7529 Azor

Saco infantil para colorir em não-tecido. Inclui 5 lápis de cera em cores variadas.

20,5 x 22 cm

1/50

100

F(1)



7530 Turcaz

Mochila infantil de corda feita de não-tecido. Com desenhos para colorir. Inclui 5 lápis de cera em cores variadas.

25 x 30 cm

1/50

200

G(1)

COLOURS INCLUDED



NEW.



7571 Solaz

Caixa de lápis em material não-tecido para crianças, com design para colorir. Inclui 5 unidades de giz de cera em cores variadas.

22 x 11 cm

1/50

200

F(1)

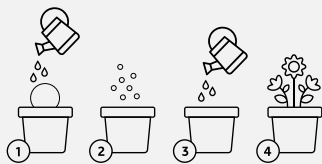

1036 **Girax**

Vaso de flores de terracota com sementes de girassol. Substrato incluído. Fabricado na UE.

6 x 5 x 5 cm 1 200

E(1)



MADE IN
EUROPA

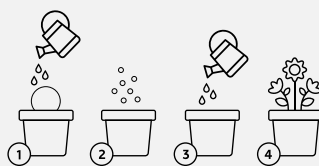

1037 **Tulsy**

Conjunto de dois vasos de flores com sementes de salsa e manjeriço. Substrato incluído. Fabricado na UE.

12 x 5 x 5 cm 1 100

E(1)

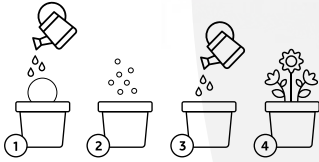

1000 **Volen**

Vaso com sementes de petúnia e vaso biodegradável.
Inclui o substrato.

6,1 x Ø6,40 cm 1/25 200

E(4)



BIODEGRADABLE FLOWERPOT



1314 **Citrus**

Difusor de aromas e humidificador. Vaporização constante com luzes LED multicores. Capacidade para 130 ml. Cabo incluído. Apresentação em caixa de design ecológico.

9,5 x Ø10 cm

1

50

E(1)

CHILL & RELAX



BAMBOO



VANILLA SCENT



1315 **Vanila**

1315 **Vanila**

Vela aromática em vidro translúcido e tampa de bambu. Fragrância de baunilha. Apresentação em caixa de design ecológico.

8,8 x Ø7 cm

1

50

E(1), L2



1313 **Surna**



NATURAL CORK



VANILLA SCENT



1313 **Surna**

Vela aromática em recipiente de vidro com tampa de cortiça. Fragrância de baunilha. Cartão kraft para impressão incluído. Apresentação em caixa de design ecológico.

7,6 x Ø5,60 cm

1/25

100

E(1)

SCENT
YOUR HOME
NATURAL FINISHES

CANDLES

FOR HOME

1307 King

Vela perfumada com recipiente em louça cerâmica. Inclui giz branco. Apresentação em caixa de papel Kraft.

7,8 x Ø7 cm 1 50

E(1), L1



01 260 60



251 02

1306 Flake

Vela perfumada com cores vivas e combinadas com recipiente de metal. Caixa com tampa transparente.

3 x Ø6,30 cm 1/50 250

E(1), L1



01 03 31 60
05 226 40 02

1311 Kimi

Vela aromática num vaso de vidro de várias cores e fragrâncias (café, pinheiro, lavanda, baunilha e morango). Apresentado em caixa individual.

6,7 x Ø5,60 cm 1 50

F(1), L1



512

1312 Maka

Vela em suporte de madeira com desenhos de Natal (estrela e árvore). Apresentado em caixa individual.

8,7 x 2,1 x 8,4 cm 1/100 200

E(1), L1



511

MOBILE PHONE HOLDERS



BAMBOO

4094 Stelo

Chaveiro com função de suporte para telemóvel feito de bambu.

6 x 1,4 x 2,6 cm 1/100 500

D(4), L1, W



BAMBOO

3010 Lyra

Suporte de bambú natural para telemóveis. Sulco inferior para cabo de carga. Inclui 2 partes de fácil montagem.

8 x 8,1 x 12 cm 1/50 100

D(4), L2, W



BAMBOO

3055 Antix

Suporte para dispositivos móveis, tablet ou smartphone, feitos de bambu natural.

6 x 2 x 8 cm 1/50 200

D(4), L1, W



BAMBOO

4110 Boncer

Chaveiro de bambú natural com função de suporte para telemóvel.

8,5 x 2,9 x 0,8 cm 1/100 600

D(4), L1

**4109 Marbel**

Chaveiro de madeira natural em dois formatos de terminações em elegante couro sintético.

8,5 x 0,5 cm 1/100 800

D(4), L1



982

983

**4054 Budan**

Chaveiro em madeira natural. Especial para gravação a laser.

10,4 x Ø5 cm 1/200 800

D(4), L1

0,5 x Ø5 cm



982

983

6 x 0,3 x 3,5 cm



4 x 0,5 x 6 cm

981

0,5 x Ø5 cm

982

**4053 Hibis**

Chaveiro em cortiça natural.

3,9 x 8,1 cm 1/200 800

D(1), L1

**4092 Sila**

Chaveiro de madeira natural em dois formatos com anel metálico. Ideal para marcação a laser.

7,2 x Ø3,90 cm 1/100 1000

D(4), L1



3 x 8,8 x 0,6 cm

Ø3,9 x 0,6 cm

**4108 Yate**

Chaveiro de isopor flutuante com corda resistente em poliéster.

9 x 1,5 x 4 cm 50 400

D(1), L1



02

05



60 05 226 40 251 02

4070 **Sparkling**

Porta-chaves em alumínio.

1,1 x 6,7 x 1,5 cm 1/200 1000

D(4), L1



60 05 226 251 02

4071 **Stout**

Porta-chaves em alumínio com forma de garrafa.

3 x 8,9 x 0,2 cm 1/100 1000

D(4), L1



31 60 05 226 251 02

4074 **Malt**

Porta-chaves em alumínio.

7,9 x 1,5 cm 1/200 1000

D(4), L1

4207 **Bioko**

Porta-chaves abridor de alumínio.

6 x 1,5 x 1,1 cm 1/200 1000

D(4),L1



60 05 226 251 02



NEW.



60 05 226 251 02

4072 Lager

Abridor de garrafas em alumínio com design clássico.

3,8 x 8,5 x 0,3 cm 1/100 1000

D(4), L1



60 05 226 251 02

4073 Pale

Porta-chaves de mosquetão em alumínio.

3 x 5,8 cm 1/200 1000

D(1), L1



01 05 226 02 60

4050 Tonic

Porta-chaves com moeda para carrinho de compras. Metálico com esmalte colorido.

6 x Ø2,30 cm 1/100 1000

D(1)

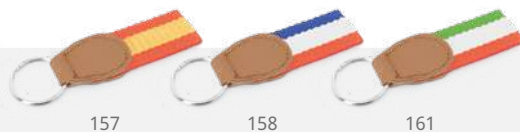

4080 Flag

Porta chaves em poliéster com desenho de bandeira e reforço em PU.

12 x 3 cm

1/50

400

E(1), L1



4051 Mineral

Porta-chaves metálico com risca colorida em poliéster.

2,8 x 6,5 x 0,6 cm 1/50 300

D(4), L1



1004 Tresna

Chaveiro Flexómetro de 1 metro com mecanismo de fecho e lâmina metálica.

4,3 x 4,4 x 1,8 cm 1/50 500

D(1), V



4079 Sito

Porta chaves com ursinho de peluche produzido em poliéster macio e com camisola de cor.

6,5 x 7,5 x 4 cm 1/20 500

E(1), N(8)





01

03

60

05

226

02

1228 **Seyku**

Bola anti-stress em PU de cor sólida.

📏 Ø6,20 cm

📦 1/20

📦 400

👤 E(1)

NEW.
COLOR



01



60

ANTI-STRESS



1229 **Biku**

Coração anti-stress em PU de cor lisa.

📏 7 x 7 x 4 cm

📦 1/20

📦 400

👤 E(1)

NEW.



60



05

1232 **Dona**

Bola de tensão em forma de gota em PU de cor lisa.

📏 8 x Ø6 cm

📦 1/20

📦 400

👤 E(1)

TOOLS & PET CARE



3984 **Sorby**

Multiferramentas em aço inoxidável. Design compacto. 11 funções, incluindo chaves de fenda e ferramenta para corrente. Apresentação em caixa de design.

9,1 x 1,8 x 4,6 cm 1/20 60

E(1), L2



NEWSORBI



TOOLS SET



4127 **Turner**

Caixa de ferramentas com 20 acessórios incluídos: X-acto, chaves de caixa hexagonais, chaves estrela e normal, e respetivo adaptador.

4,9 x Ø12,90 cm 1 30

F(2)





8024 **Kanchan**

Esferográfica multi ferramenta 4 em 1: nível, régua em centímetros e polegadas, chave de parafusos de cabeça plana e estrela. Corpo com acabamento metalizado, mecanismo giratório e clip metálico. Tinta azul.

14,9 x Ø1,00 cm 1/50 1000
 B(4)

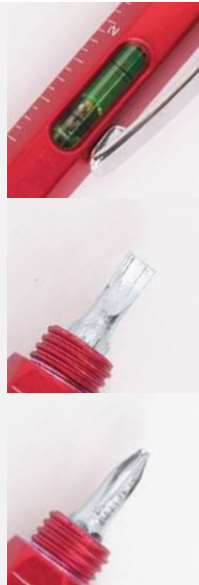

NEW.



3991 **Brico**

Multiferramentas de alumínio em forma de caneta. 8 cabeças de chave de fenda, estrela e plana incluídas.

11 x Ø1,30 cm 1/50 200
 C(1), L1



0108 **Lock**

X-ato de lâmina larga e corpo em ABS. Pega ergonómica cortada e tampa extraível para corte e ajuste da lâmina.

3 x 15,5 x 1,4 cm 1/100 500
 C(4)



8088 Veta

Lápis de carpinteiro em formato oval para uma fácil marcação. Ponta sem afiar.

17,6 x 1,2 cm 100 1000

A(4), L1



8003 Mata

Mini-lápis em madeira com acabamento em borracha natural. Corpo redondo.

10 x Ø0,50 cm 100 2000

A(4)



9921 Franklin

Óculos transparentes anti-embaciantes. Astes laterais ventiladas. Fabricado em policarbonato leve.

15,5 x 5,7 x 15 cm 1/10 200

D(4)



01



02

0104 Sherlock

Lupa conta fios dobrável, com 7 aumentos. Com régua de medição integrada no corpo. Apresentação em caixa individual.

4,5 x 4,5 x 1,4 cm 1/50 400

C(4)

SHERLOCK

PICK

RIVET



5M

0106 **Pick**

Fita métrica de 5 metros homologada, com mecanismo de bloqueio e lâmina metálica. Corpo de cor com capa de borracha, clip metálico e asa de transporte. Apresentação em caixa individual.

7 x 3,5 x 7 cm 1/10 50
E(1)

3M

0105 **Rivet**

Fita métrica de 3 metros homologada, com mecanismo de bloqueio e lâmina metálica. Corpo de cor com capa de borracha, clip metálico e asa de transporte. Apresentação em caixa individual.

6,5 x 3 x 6 cm 1/10 50
E(1)

WORK ACCESSORIES

NEW.

NEW.



BAMBOO

1026 **Dovel**

Flexômetro de 5 m com mecanismo de bloqueio e gancho de tira metálica. Grampo de metal, alça de transporte e detalhes em bambu. Apresentação em caixa de design ecológico.

6,5 x 6,5 x 3,1 cm 1/30 60
E(4), L1

3983 **Dintel**

Balança de alumínio com design triangular de 30 cm. Escalas 1:20, 1:25, 1:50, 1:75 e 1:100. Um lado plano, especial para marcação. Apresentação em caixa de design.

32 x 2 x 2 cm 1/50 200
F(4), L1



3 LIGHT MODES



01 60 05 226 02

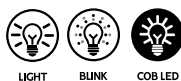

0110 Flash

Lanterna desportiva com fita para ajuste multiusos. 8 luzes LED COB com 3 modos de iluminação. 3 pilhas AAA não incluídas. Apresentação em caixa individual.

6,1 x 4 x 1,7 cm 1/100 500

E(1)



MANUAL CHARGE



03 60 05 226 02

0107 Brill

Lanterna com 3 luzes LED e carga manual. Disponível em várias cores translúcidas, com asa de transporte de cor cinza a combinar com o botão. Apresentação em caixa individual.

10,5 x 5 x 2,5 cm 1/25 200

D(4), V

ALWAYS WITH LIGHT



60 05 251 02

8023 Araya

Esferográfica lanterna de luz LED com corpo ABS metalizado. Mosquetão integrado na tampa. Tinta azul

11 x Ø1,00 cm 1/50 500

B(4)



60 05 251 02

0109 Hale

Lanterna em alumínio com acabamento metalizado com 1 LED. Inclui mosquetão de transporte a combinar. Pilhas de botão incluídas.

6 x Ø1,50 cm 1/100 600

D(4), L1

3990 **Goliat**



3989 **Vidur**



3988 **Kaide**



NEW
KNIVES



NEW.



NEW.



NEW.



BAMBOO



3988 **Kaide**

Faca de aço inoxidável com aderência em bambu. Alça de transporte ajustável incluída. Apresentação em caixa de design ecológico.

9,7 x 2,5 x 1,1 cm 1/10 250

E(4), L1



NATURAL WOOD



3989 **Vidur**

Faca em aço inoxidável e aderência correspondente em madeira natural. Bloqueio de segurança. Apresentação em caixa de design ecológico.

9,1 x 2,4 x 1,4 cm 1/10 100

E(4), L1



NATURAL WOOD



3990 **Goliat**

Faca de aço inoxidável com lâmina em preto e punho em madeira natural. Bloqueio de segurança. Apresentação em caixa de design ecológico.

9 x 2,6 x 1,2 cm 1/10 100

E(4), L1





MURDOCK



BAMBOO

4120 **Murdok**

Multi-ferramentas com corpo e acessórios em aço inoxidável e punho de bambú. 12 funções: navalha, serra, lixas, abridores, chaves de fenda, e alicates. Inclui correia para transporte. Apresentação em caixa eco.

 5 x 1,7 x 10,5 cm  1/10  100

 E(4), L1



BINTAL



4096 Bintal

Canivete polivalente com acessórios em aço inoxidável e corpo em bambu. 9 funções. Inclui correia de transporte em pele. Apresentação em caixa ecológica.

9 x 1,6 x 2,3 cm 1/50 100

E(4), L1

..... 9 FUNCTIONS



4095 Zora

Canivete multiusos em aço inoxidável com 6 funções: faca, abre-latas, saca-rolhas, chave de fendas e porta-chaves. Apresentação em caixa branca.

7,6 x 2,1 cm 1/20 200

E(4), L1

ZORA



..... 9 FUNCTIONS



PINE

OCEAN

BARRIES

LAVANDER



01

60

05

226

4 COLOURS

DIFFERENT SCENTS

1316 Rindal

Purificador de ar com diferentes aromas em recipiente de vidro com tampa de madeira e cordão ajustável correspondente. Capacidade de 5 ml. Apresentação em caixa transparente.

4,8 x Ø2,30 cm

1/100

400

D(4)

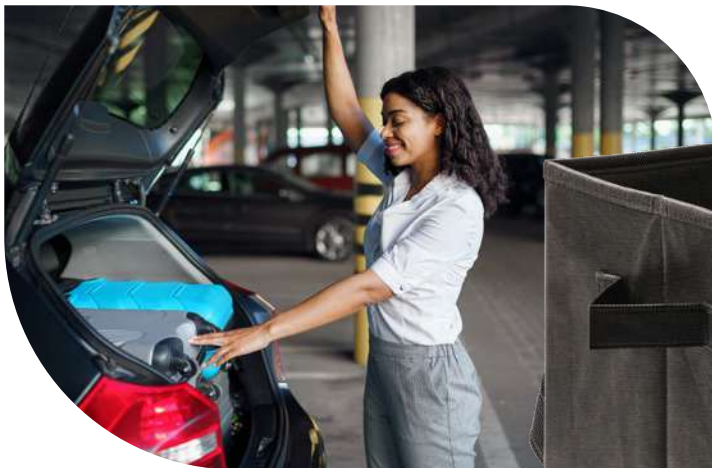

7169 Rifter

Organizador de guarda-malas para carro em resitente non-woven. Alças de transporte reforçadas, alças laterais e bolsos frontal. Base rígida para um melhor ajuste.

34 x 28 x 25 cm

1

40

G(1), N(8)



TRAVEL ORGANISER



4128 **Nisek**

Luva raspadora de gelo com interior forrado em poliéster 210T

25 x 1,5 x 17 cm /20 100
E(1), N(8)

ICE SCRAPERS



4142 **Alsen**

Raspador de gelo de design compacto. Um lado dentado e dois lados lisos.

11 x 11,7 x 0,2 cm 50 600
D(2)



4143 **Nosok**

Raspador de gelo em bambu com um lado dentado e outro liso.

12,4 x 0,6 x 10,8 cm 1/50 200
E(1)



EN ISO 13688:2013
 EN ISO 20471:2013/A1:2016
CLASS 2

5063 **Sirio**

Colete de alta visibilidade com duas faixas reflectoras no peito e costas. Gola em bico e fecho de velcro ajustável.

Certificação CE segundo as normas: EN ISO ISO 13688:2013/A1:2021 e EN ISO 20471:2013/A1:2017. Classe II.

1 100

SAFETY & PREVENTION

NEW.



5627 **Gante**

Cobertor térmico para atividades desportivas. À prova de água e vento. Face interior em alumínio.

210 x 130 cm 1/50 200

D(1)



SUNSHADES

1007 **Mack**

Kit de 2 guarda-sóis dobráveis para janelas. Inclui ventosas. Apresentação em capa de PVC.

 44 x 38 cm

 1/25

 100

 F(1)

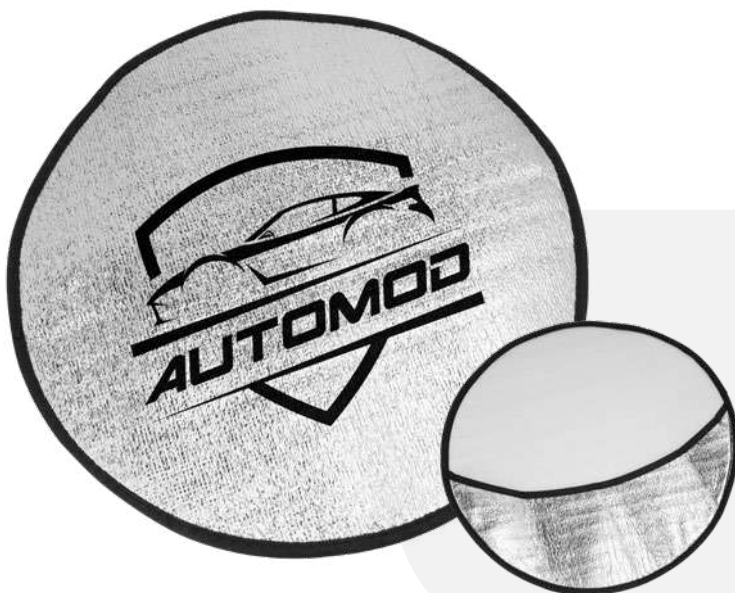
0103 **Bora**

Capa redonda para volante, com capa frontal em alumínio metalizado. Debruado em cor preta. Apresentação plana.

 Ø44,00 cm

 200

 F(1)

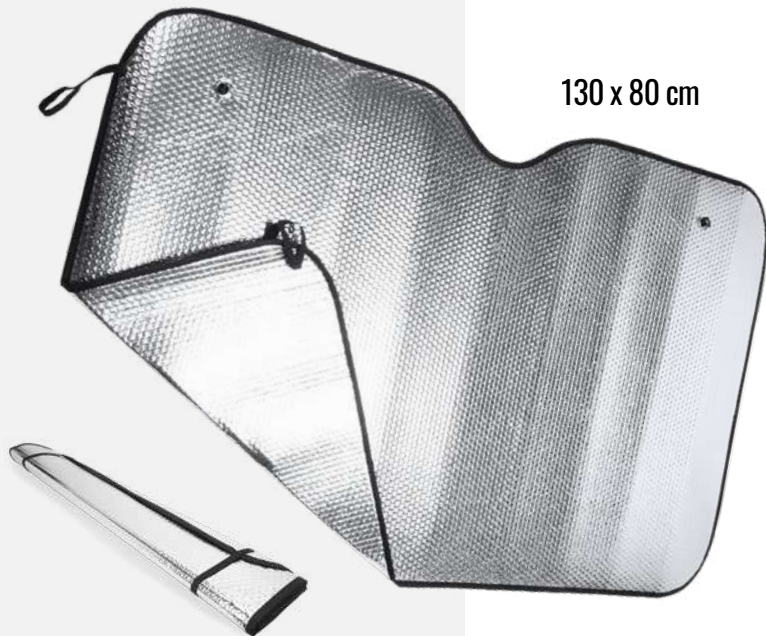

130 x 80 cm

0102 Batur

Pará sol tamanho maxi, de dupla face tipo bolha em folha de alumínio de acabamento metalizado, debruado em poliéster e com argolas metálicas reforçantes. Inclui argolas metálicas com ventosas e elásticos para dobrar. Apresentação plana.

130 x 80 cm

100

G(1)

180 x 90 cm

**1017 Columbia**

Guarda-sol de grandes dimensões ideal para Caminhões e Vans. Bolha de dupla face, realizada em alumínio acabado metálico e afiação em negro. Inclui anéis de metal com ventosas e tiras elásticas para colagem. Apresentação em plano.

180 x 90 cm

50

G(1)

TRUCK SUNSHADE

150 x 70 cm

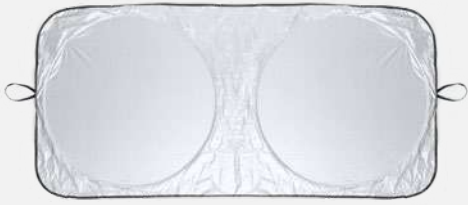

1008 **Prisma**

Guarda-sol dobrável de poliéster 170T. Inclui prática capa a jogo.

150 x 70 cm

1/50

100

G(1)



POUCH INCLUDED



130 x 65 cm

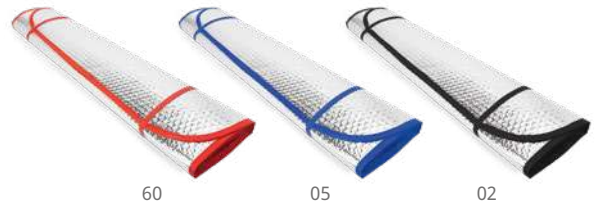
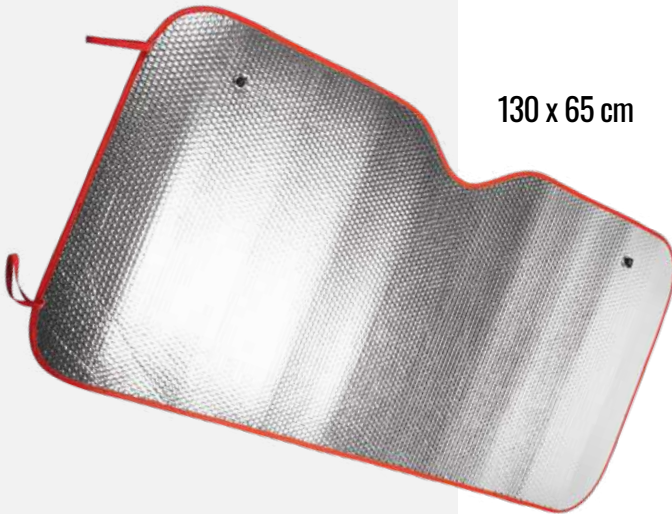

60

05

02

0101 **Kini**

Pará sol de dupla face tipo bolha, produzido em folha de alumínio com acabamento metalizado e debruado em cor. Inclui argolas metálicas com ventosas e elásticos para dobrar. Apresentação plana.

130 x 65 cm

100

G(1)

130 x 60 cm

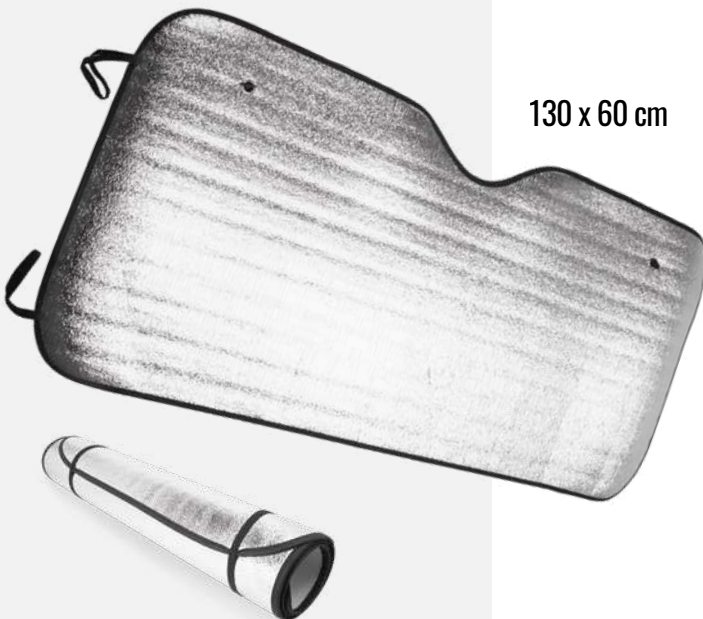

0100 **Akala**

Pará sol com frente em folha de alumínio de acabamento metalizado, debruado em poliéster e com argolas metálicas reforçantes. Inclui argolas metálicas com ventosas e elásticos para dobrar. Apresentação plana.

130 x 60 cm

100

G(1)





60

05

02

1021 **Korat**

Coleiras para animais de estimação em resistente e suave poliéster. Correia ajustável e fivela com clique de fechamento. Inclui anel de metal para coleira.

 51 x 2,5 cm  1/20  300

 F(1)

PET CARE

THE BEST FOR YOUR PARTNER



01

03

31

60

05

226

02

1018 **Simba**

Dispensador de bolsas para animais de estimação com mosquetão de transporte a jogo. Inclui 15 bolsas.

 8,2 x 4,1 x 5,4 cm  1/50  200

 D(4)





60

05

226

1019 Shira

Tijela dobrável para animais de estimação. Adequado para líquidos e sólidos. Capacidade 450 ml. Inclui mosquetão metálico para transporte a jogo.

5,2 x Ø12,90 cm 1/50 200

L2



NEW.



29



RECYCLED PET

1024 Muntok

Tijela dobrável para animais de estimação em papel PET e reciclado. Adequado para sólidos e líquidos. 1,3 litros de capacidade.

10 x Ø17,00 cm 1/10 200

F(1)



03

60

05

1020 Lanza

Bola para animais de estimação em borracha resistente e tecido reforçado.

Ø6,40 cm 1/20 200

N(8), L1



NEW.



01

60

05



RECYCLED PET

1025 Demak

Frisbee para animais de estimação com tecido central em PET e cabo de algodão.

Ø20,00 cm 1/10 100

F(1), N(8), R

WINTER & RAINY DAYS

130x165 cm



POLAR FLEECE | SHERPA

GLORY



06

55

47



5626 **Glory**

Manta estilo sherpa em lã 380 g/m². Inclui cartão ideal para impressão e fita de cor condizente.

 130 x 165 cm

 1

 10

 F(1), N(8), O, P

100% RECYCLED POLYESTER



05



58



02



RECYCLED
PET



ANTIPELLING

5624 **Brandon**

Coberta de velo de poliéster reciclado RPET com cobertura prática. Tratamento anti-pilling. 180 200 g/m².

150 x 120 cm



G(1), H(1), N(8), O, P



BREATHABLE



60



55



58



02



ANTIPELLING

5622 **Bering**

Coberta com capa prática a condizer em acabamento Oxford com malha. Tratamento anti-borbot. 100% poliéster 200 gr / m².

130 x 160 cm



G(1), H(1), N(8), O, P



60 05 55 226 58 02



ANTIPILLING

5625 Daneris

Manta polar com tratamento anti borboto. Inclui asa de transporte com fecho de velcro. 100% poliéster de 200g/m²

160 x 130 cm

1

25

F(1), N(8), O, P



31 60 05



226 58 02



ANTIPILLING

5621 Lambert

Coberta com tratamento anti-borboto. 100% poliéster 180 gr / m².

120 x 150 cm

1

20

N(8), O, P





POLAR FLEECE

WATERPROOF



REVERSIBLE



07

15

55

02

6998 Frosty

Gorro de lã estilo bob reversível. Exterior de nylon e forro interior polar.

Ø60 cm

25

100

F(1), N(8), O



PROLY

ANN REFORMS



01

60

55

05

02

9009 Planet

Gorro de malha com dupla volta na parte inferior.

10 200

N(8), O, P



06

60

05

55

107

40

58

02

6997 Bulnes

Gorro com duas camadas em poliéster. Frente dobrável, ideal para rotulagem.

22 x 21 cm

1/10

200

E(1), N(8)

NEW.



56 56 58 02

9947 Delun

Aquecedor de pescoço multifuncional em algodão orgânico de 150 g/m².

25 x 50 cm 1/10 100
G(1), N(8), O, P



2009 Nukka

Gola polar com ajustador elástico.

30 x 25 cm 10 100
G(1), N(8), O, P, R



SUBLIMATION



01 03 31 60 55
05 226 02 78

9004 Nanuk

Gola tubular multifuncional.

25 x 50 cm 25 500
G(1), N(8), R



5623 Zeland

Luvas táteis (polegar, indicador e dedo médio). Zona de tacto com cor diferente do resto da luva. Tamanho único (adulto). Fabricado em acrílico.

21 x 11,5 cm 1/10 200
N(8)



03



60



05

5600 **Damper**

Poncho impermeável dobrável, com capuz e abertura para os braços, acabamento termo selado e fecho central com colchetes. Tamanho único 127 x 100 cm. Produzido em PVC. Bolsa para acondicionamento incluído.

 22,5 x 18 cm

 1

 50

 F(1), H(1)

RAINY DAYS



01



03



60



05

 POUCH INCLUDED

5603 **Baikal**

Capa de chuva impermeável com acabamento termo-selado, fecho central com 4 fechos de correr, bolsos laterais com aba, punhos com fecho de botão, 3 aberturas de ventilação nas costas e campânula ajustável com cordão. Um tamanho adulto. Inclui coldre.

 86 x 72 cm

 1/10

 50

 F(1)





5602 **Vostok**

Capa de chuva impermeável compostável. Com capuz e abertura para os braços. Tamanho único para adultos de 127x102 cm. Fabricado em ácido láctico poliácido (PLA). Apresentação em bolsa individual PLA.

 127 x 102 cm  1/50  200

 E(1)



01

03

60

05

226

5601 **Shaka**

Capa de chuva dobrável à prova de água. Com capuz e abertura para os braços. Tamanho único para adultos de 127x102 cm. Fabricado em polietileno de baixa densidade (LDPE). Apresentação em bolsa individual.

 127 x 102 cm  1/50  200

 E(1)



23 55 02

5998 Osaka

Guarda-chuva em poliéster pongee 190T com pega em material suave. Abertura automática. Varetas em fibra de vidro à prova de vento e pontas reforçadas.

82 x Ø107 cm 1 25

G(1), N(8)



WINDPROOF

**5609 Harul**

Guarda-chuva XL 190T de poliéster com alça, haste e acabamento em preto. Hastes longas de fibra de vidro. Botão de abertura automática. Pega em EVA. Fecho de velcro a condizer.

98 x Ø130 cm 1 25

G(1), N(8), R

SUBLIMATION



01 60 55 05 02



SUBLIMATION



Ø105

01 60 05 226 02 0102

5611 Fargo

Guarda-chuva com cabo de madeira e abertura automática. Costelas e extremidades negras. Fecho de velcro. Feito de poliéster 190T.

85 x Ø105 cm 1 40
G(1), N(8), R

WOODEN HANDLE



Ø105



01 03 31 60 05 226 02

5608 Milford

Guarda-chuva com tecido e alça a combinar. Varetas e acabamentos em preto. Fecho com velcro. Abertura automática. Fabricado em poliéster 190T.

83 x Ø105 cm 1 25
G(1), N(8), R



SUBLIMATION

NEW.
COLOR



Ø105

01 60 55 05 226 02 63

5607 Lyse

Guarda-chuva com cabo, acabamentos em cana e madeira. Varetas em preto. Fecho em velcro a condizer. Abertura manual. Fabricado em poliéster 190T.

90 x Ø105 cm 1 25
G(1), N(8), R





NEW.



01 55 46 02



5605 Miyagi

Guarda-chuva dobrável com abertura automática. Tecido pongee 190T com bolsa condizente. Cabo EVA e costelas de metal preto.

☰ Ø98 cm

📦 1

📦 30

👤 G(1), N(8), R

**AUTO
OPEN&CLOSE
UMBRELLA**



01 60 55 02

5999 Nauro

Guarda-chuva com fecho automático em poliéster pongee 190T com saco condizente. Varetas e pontas pretas e pega em bambu. Fecho condizente em velcro.

☰ 57 x Ø100 cm

📦 1

📦 30

👤 G(1), N(8), R





5606 **Yaku**

Guarda-chuva dobrável com abertura manual e saco a condizer. Cabo, hastes e ponta prateados. Fecho com velcro. Fabricado em poliéster 190T.

24 x Ø5 cm

1

60

G(1), N(8), R

SUBLIMATION



01 03 31 60 05 226 02 40 63

NEW.
COLOR



100% RECYCLED POLYESTER

SUBLIMATION



01 60 05 02



5610 **Khasi**

Guarda-chuva dobrável em poliéster reciclado 190T RPET com bolsa a condizer. Cana, hastes e terminações em preto. Cabo em madeira natural. Fecho de velcro a condizer e abertura manual.

27,5 x Ø5,80 cm

1

50

G(1), N(8), L2



WOODEN HANDLE

SUBLIMATION



7618 **Miso**

Saco ideal para sublimação em poliéster resistente e suave. Alças longas de 70 cm.

42 x 38 cm

10

100

F(6), N(8), R

POLYESTER WITH COTTON TOUCH



7569 **Osak**

Nécessaire, ideal para sublimação, em poliéster suave e com forro interior. Fecho de correr com puxador condizente.

22 x 14 x 6,5 cm

1/25

500

F(1), N(8), R



7180 **Kanda**

Mochila de cordão, ideal para sublimação, em poliéster macio e resistente.

42 x 34 cm

10

100

F(1), N(8), R



7114 **Hamelin**

Mochila de cordões com ilhós de metal, realizadas em poliéster 210D. Etiqueta removível.

34 x 42 cm 50 300

F(1), N(8), R



7152 **Ninfa**

Mochila de cordões com esquinas reforçadas realizadas em poliéster 210D. Bolso frontal com zíper e saída para cabos. Etiqueta removível.

34,5 x 45 cm 10 200

F(1), N(8), R



7550 **Larus**

Mochila com cordão em poliéster RPET macio com cantos reforçados.

34 x 42 cm 50 300

F(1), R



7154 **Sison**

Mochila leve e compacta, Em poliéster resistente 600D. Bolso frontal com abertura vertical e alcochoado nas costas e alças. Etiqueta removível.

23 x 40 x 12 cm 1 50

F(1), N(8), O, R



7127 **Trento**

Sacos não tecidos sublimáveis de 80 g/m² com alças robustas cortadas sob pressão e acabamento termo-selado. Ideal para sublimação.

34 x 43 cm 20 400
F(1), N(8), R



7527 **Mito**

Saco tote não tecido costurado com alças reforçadas. Ideal para sublimação. Alças de 70 cm.

36 x 40 cm 50/50 250
F(1), N(8), R



8110 **Cloud**

Caixa para óculos com cordões de fecho automático. Poliéster com toque macio.

9 x 18 cm 50 1000
D(1), N(8), R



7549 **Pantala**

Bolsa de compras dobrável fabricado com RPET de poliéster reciclado macio. Inclui bolsa prática para dobrar.

33 x 46 x 8 cm 20 400
F(1), G(1), R

7522 **Toco**

Saco de compras dobrável em poliéster 190T macio com acabamento costurado. Inclui elástico prático para dobrar.

42,5 x 38 x 7 cm 1/20 400
F(1), G(1), H(1), R



800ml

4144 Magun

Garrafa de aço inoxidável 304 em acabamento robusto. Capacidade para 800 ml. Apresentação em caixa de design.

22,5 x Ø7,40 cm 1 40

F(1), L2, L3, Q

DOUBLE WALL

600ml

4139 Torke

Garrafa térmica de parede dupla em aço inoxidável 304. Capacidade para 600 ml. Apresentação em caixa de design.

26 x Ø6,90 cm 1 30

F(1), L2, L3, Q



BAMBOO

DOUBLE WALL

620ml

4039 Boina

Recipiente em aço inoxidável 304 e bambu. Especial para marcar em sublimação. Capacidade de 620 ml. Apresentação em caixa de design.

21 x Ø7,30 cm 1 50

F(1), L2, Q

700ml

4200 Selby

Garrafa de aço inoxidável 304, especial para sublimação. 700 ml de capacidade. Apresentação em caixa de design.

25,7 x Ø7,10 cm 1 40

L2, L3, Q

DOUBLE WALL

500ml



4059 Copo

Garrafa térmica de aço inoxidável 304 com parede dupla especial para sublimação. Capacidade 500 ml. Apresentado em caixa de desenho.

25,5 x Ø7,30 cm 1 24

L2, L3, Q



4122 **Balax**

Garrafa térmica de parede dupla em aço inoxidável 304. Parede dupla com isolamento a vácuo de cobre. 550 ml de capacidade. Apresentação em caixa de design.

22,5 x Ø7,40 cm 1 30
F(1), L2, L3, Q

4126 **Fancy**

Garrafa térmica em aço inoxidável 304. Parede dupla com isolamento de cobre. Capacidade 500ml. Apresentação em caixa própria.

26,3 x Ø7 cm 1 30
F(1), L2, L3, W, Q

4045 **Athletic**

Recipiente em alumínio com mosquetão. Capacidade de 400ml. Apresentação em caixa de design.

17,5 x Ø6,60 cm 1 50
F(1), L2, Q



4049 **Baobab**

Recipiente em alumínio com mosquetão. Capacidade de 800 ml. Apresentação em caixa de design.

24,6 x Ø7,30 cm 1 50
F(1), L2, L3, W, Q

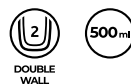

4123 **Salvia**

Frasco de aço inoxidável 304 de parede dupla. Acabamento brilhante. Capacidade de 500 ml.

24,5 x Ø6,90 cm 1 30
F(1), L2, L3, Q



NEW.



3986 **Adaya**

NEW.



4148 **Puket**



4040 **Camu**



4098 **Kaster**



4060 **Kaffir**



BOROSILICATE GLASS

3986 **Adaya**

Caneca de vidro borossilicato fosco, especial para sublimação. Capacidade para 500 ml. Apresentação em caixa branca.



BOROSILICATE GLASS

4148 **Puket**

Copo de vidro de borossilicato fosco, especial para sublimação. 330 ml de capacidade. Apresentação em caixa branca.



4040 **Camu**

Recipiente em vidro de 500 ml. Caixa e cinta de transporte coloridas. Apresentação em caixa de design.

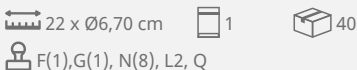

F(1), G(1), N(8), L2, Q



4060 **Kaffir**

Caneca cristal de 340 ml. Especial para sublimação. Apresentação em caixa individual eco.



F(1), Q



4098 **Kaster**

Garrafa de vidro de 600 ml. Inclui estojo de cor com pega de transporte. Apresentação em caixa de desenho.



F(1), N(8), L2, R

PREMIUM QUALITY

3999 **Lemon**

350 ml

3999 **Lemon**

Chávena de cerâmica de alta qualidade, especial para sublimação. Capacidade para 350 ml. Caixa individual não incluída. Apresentação em caixa de 36 unidades.

9,6 x Ø8,20 cm

1

36

4003 **Rambu**4000 **Lima**4084 **Marang**

350 ml

4003 **Rambu**

Caneca cerâmica de 350 ml com design em acabamento mate. Especial para sublimação. Apresentação em caixa branca.

9,6 x Ø8,20 cm

1

36



350 ml

4000 **Lima**

Caneca cerâmica de 350ml especial para sublimação. Apresentação em caixa branca.

9,6 x Ø8,20 cm

1

36



250 ml

4084 **Marang**

Caneca cerâmica de 250 ml especial para sublimação. Apresentação em caixa branca.

8,4 x Ø7,40 cm

1

48



700ml

3987 **Samui**

Caneca de cerâmica com acabamento brilhante, especial para sublimação. 700 ml de capacidade. Apresentação em caixa branca.

13,8 x Ø10,40 cm 1

20



NEW.



NEW
SAMUI



0160

0105

0102

300ml

4002 **Kumbo**

Taça de cerâmica com design retro especial para sublimação. Capacidade de 300 ml. Apresentação em caixa branca.

8,5 x Ø8,70 cm 1

36



380ml

4014 Damasco

Caneca metálica estilo retro. Especial para sublimação. Capacidade 380ml. Apresentação em caixa branca.

7,9 x Ø8,80 cm 1 48

L2, Q



MAGIC
MUGS



350ml

4085 Okra

Caneca mágica em cerâmica com acabamento mate. Capacidade 350 ml. Verte líquido quente sobre a mesma e descobre o desenho escondido. Apresentação em caixa branca.

9,6 x Ø8,20 cm 1 36

F(1), Q



350ml

4001 Mango

Caneca cerâmica de 350ml especial para sublimação. Interior e asa coloridos. Apresentação em caixa branca.

9,6 x Ø8,20 cm 1 36

Q



0103

0131

0160

0105

01226

0102





Ø105

5611 Fargo

Guarda-chuva com cabo de madeira e abertura automática. Costelas e extremidades negras. Fecho de velcro. Feito de poliéster 190T.

85 x Ø105 cm 1 40

G(1), N(8), R



Ø105

5607 Lyse

Guarda-chuva com cabo, acabamentos em cana e madeira. Varetas em preto. Fecho em velcro a condizer. Abertura manual. Fabricado em poliéster 190T.

90 x Ø105 cm 1 25

G(1), N(8), R



Ø105

5608 Milford

Guarda-chuva com tecido e alça a combinar. Varetas e acabamentos em preto. Fecho com velcro. Abertura automática. Fabricado em poliéster 190T.

83 x Ø105 cm 1 25

G(1), N(8), R



WINDPROOF

Ø130

5609 Harul

Guarda-chuva XL 190T de poliéster com alça, haste e acabamento em preto. Hastes longas de fibra de vidro. Botão de abertura automática. Pega em EVA. Fecho de velcro a condizer.

98 x Ø130 cm 1 25

G(1), N(8), R



Ø95



5606 **Yaku**

Guarda-chuva dobrável com abertura manual e saco a condizer. Cabo, hastes e ponta prateados. Fecho com velcro. Fabricado em poliéster 190T.

24 x Ø5 cm

1

60

G(1), N(8), R



Ø95



WINDPROOF



5610 **Khasi**

Guarda-chuva dobrável em poliéster reciclado 190T RPET com bolsa a condizer. Cana, hastes e terminações em preto. Cabo em madeira natural. Fecho de velcro a condizer e abertura manual.

27,5 x Ø5,80 cm

1

50

G(1), N(8), L2

Ø100



5999 **Nauro**

Guarda-chuva com fecho automático em poliéster pongee 190T com saco condizente. Varetas e pontas pretas e pega em bambu. Fecho condizente em velcro.

57 x Ø100 cm

1

30

G(1), N(8), R



Ø98

5605 **Miyagi**

Guarda-chuva dobrável com abertura automática. Tecido pongee 190T com bolsa condizente. Cabo EVA e costelas de metal preto.

Ø98 cm

1

30

G(1), N(8), R

2998 **Sonic**

Tapete de rato XL. Superfície macia de poliéster, especial para sublimação, e base antiderrapante. Apresentação individual.

 70 x 35 cm

 1/10

 30

 F(1), R



3011 **Sira**

Tapete de rato com design plano. Superfície em poliéster macio e base em silicone antiderrapante.

 22 x 18 cm

 1/100

 200

 E(1), N(8), R

3012 **Silvano**

Tapete de rato em poliéster suave com apoio de pulso acolchoado. Base antiderrapante em silicone.

 20,5 x 24,3 x 2 cm

 1

 100

 E(1), N(8), R



2997 **Yuba**

Tapete de rato redondo. Superfície macia de poliéster e base antiderrapante.

 Ø20 cm

 1/100

 200

 E(1), N(8), R



3097 **Areta**

Pulseira ajustável de poliéster especial para sublimação.

30 x 1,5 cm

10000



SECURITY CLASP

3095 **Spring**

Pulseira de poliéster ajustável, específica para sublimação.

30 x 1,5 cm

10000



3096 **Paradis**

Pulseira de poliéster sem fecho de pressão, específica para sublimação.

30 x 1,5 cm

10000



- Sublimation full color included
- Minimum 250pcs



4124 **Kendal**

Chaveiro com alças de poliéster, específico para sublimação.

12 x 2 cm

2000



7071 **Sinatra**

Cordão duplo de poliéster com mosquetão, específico para sublimação.

100 x 2 cm

100

500



7049 **Elvis**

Lanyard de poliéster com mosquetão especial para sublimação.

50 x 2 cm

100

500



7050 Calisto

Boné de 5 painéis com pala em contraste.
6 linhas de costura na viseira.
Quatro furações de ventilação.
Fita anti-suor interna.
Fecho com velcro.

📏 Ø60 cm 📦 25/75 📦 300
👤 F(1), N(8), O, P, R



7000 Basica

Chapéu de 5 painéis e 2 furos de ventilação bordados. 4 costuras pespontadas na pala. Cinta interior anti-suor. Fecho ajustável em velcro na parte posterior.

📦 25 📦 300
👤 Consultar



7048 Wizer

Viseira esportiva de poliéster. Com fecho de velcro e laterais alcochoados.

📦 25 📦 200
👤 F(1), N(8), O, P, R



7020 Mercury

Chapéu de 3 painéis, transpirável e de secagem rápida. Tecido técnico leve. Fecho ajustável em velcro na parte posterior.

📦 25 📦 200
👤 F(1), N(8), O, P, R



7057 Kelsey

Toalha absorvente produzida em micro fibra 185g/m². Inclui bolsa de acondicionamento com fecho ajustável.

📏 100 x 50 cm 📦 1 📦 100
👤 G(1), N(8), O, P, R



7103 Bay

Toalha absorvente produzida em micro fibra 345 g/m². Inclui manga reutilizável em PVC

📏 45 x 30 cm 📦 1 📦 100
👤 F(1), N(8), O, P, R



7119 Cork

Toalha multidesporto em microfibra. Leve, compacta e fácil de transportar. Rematada com filamento de poliéster com 3 fios no mesmo tom. Secagem rápida. Adorno elástico para enrolar.

📏 70 x 120 cm 📦 10/10 📦 100
👤 F(1), N(8), O, P, R



9001 **Crossfitter**

Fita running transpirável para a cabeça. Tecido duplo de poliéster. Personalizável.

22,5 x 8 cm 10/10 300
G(1), N(8), R



7104 **Olympia**

Fita elástica desportiva para a cabeça, produzida em micro fibra suave.

23,5 x 6 cm 1/100 800
G(1), N(8), R



7105 **Speed**

Braçadeira elástica fabricada em micro fibra macia. Bolso incorporado com fecho de correr.

10 x 9 cm 1/100 1000
E(1), N(8), R



9129 **Ducasse**

Avental comprido em popelina.

- Fita de pescoço no mesmo tom.
- Fitas laterais para laço.
- Dois bolsos frontais, um interior e outro grande sobreposto.

65 x 90 cm 10/10 100
Consultar



9134 **Roger**

Luva de cozinha em poliéster. Acabadona na cor branca, com bordas e fita em cores para pendurar.

19 x 30,5 cm 1/50 200
E(1), N(8), R

PARTY & EVENTS

LEVY NATURAL HAT



29



02

7014 **Levy**

Chapéu de fibra sintética com faixa interna de conforto.



25



100

 Consultar



01

03

31

60

05

226

02

40



7060 **Dusk**

Chapéu em poliéster.



25



200



F(1)



01

07

02

7015 **Beloc**

Chapéu em material sintético com faixa interna de conforto.



25



100

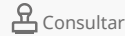

Consultar



01

07

7018 **Jones**

Chapéu de asa plana em material sintético com faixa interna de conforto.



25



100

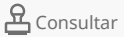

Consultar



CUSTOMIZABLE
BANDS

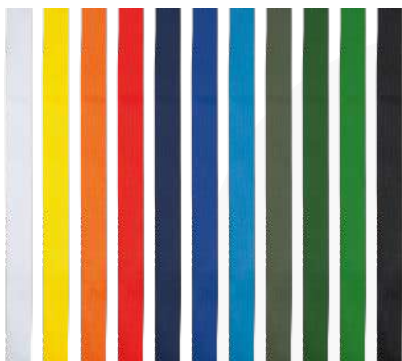

01

03

31

60

55

05

242

13

56

226

02

7013 **Comet**

Fita não tecida para chapéu.



67 x 2,7 cm



10/500



5000



Consultar

STRAW HATS

7062 **Halley**

Chapéu de palha natural com risca interior confortável.

 250

 Consultar



7061 **Sun**

Chapéu de palha natural com risca interior confortável.

 250

 Consultar



29



13

7063 **Galaxy**

Chapéu de palha natural com risca interior confortável.

 250

 Consultar



NEW.

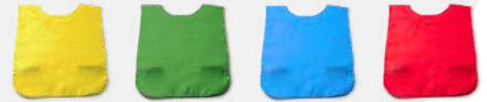

03

226

05

60

9322 **Dalic**

Camisa sem mangas desportiva em poliéster 190T. Alças elásticas laterais com fixação em velcro.

100 x 52 cm

1/25

300

F(1)

NEW
DALIE

9003 **Festero**

Lenço triangular para eventos.

100 x 70 x 70 cm

100

1000

E(1), N(8), R



01

03

31

60

57

55

63

05

10

69

24

02

48



01

03

31

60

05

226

02



3101 **Carnival**

Apito de design clássico com fio para pescoço.

1,9 x 2,4 x 5 cm

10/250

1000

C(1)

NEW.



NEW.
COLOR



01 03 31 60 63 05 226 02

3106 Jamboree

Conjunto de dois bastões infláveis e reutilizáveis em LDPE. Válvula de insuflação incluída.

61 x Ø10 cm 1/25 500

G(1)



158 161 157 162

3109 Suport

Conjunto de bastões infláveis e reutilizáveis em LDPE. Desenhos de bandeiras sortidas. Válvula de insuflação incluída.

61 x Ø10 cm 1/25 500

G(1)



01 03 31 60 05



226 63 158 157 161 162

3103 Celeb

Bandeirinhas de festas produzidas em poliéster 170T. Disponíveis em cores lisas e bandeiras.

21 x 14 cm 10 2000

D(6)



31 60 05 226 157

3105 Revel

Aplaudidor com desenho bicolor em forma de mão.



18,5 x 8,5 cm 1/100 200

E(4)

NEW.

3112 **Milos**

Ventilador manual com nervuras de madeira e tecido PET.
Apresentação em caixa ecológica.

 42,5 x 23 x 3 cm  1/25  250

 D(1), E(2), L1





NEW FANS

NEW.

3113 **Zante**

Ventilador manual com nervuras de madeira e tecido de algodão. Apresentação em caixa ecológica.

 42,5 x 23 x 4 cm  1/25  200

 D(1), E(2), L1





3110 **Albero**

Leque com varas em plástico e tecido em poliéster.
Apresentação em caixa branca.

43 x 23 cm 1/25 250

D(1), E(2)

NEW.
COLOR



3111 **Calesa**

Ventilador manual com nervuras de madeira e tecido PET.
Apresentação em caixa branca.

42,5 x 23 cm 1/25 250

D(1), E(2), L1



NEW.



3114 **Keros**

Ventilador manual com nervuras de madeira e tecido PET.
Apresentação em caixa branca.

42,5 x 23 x 3 cm 1/25 250

D(1), E(2), L1

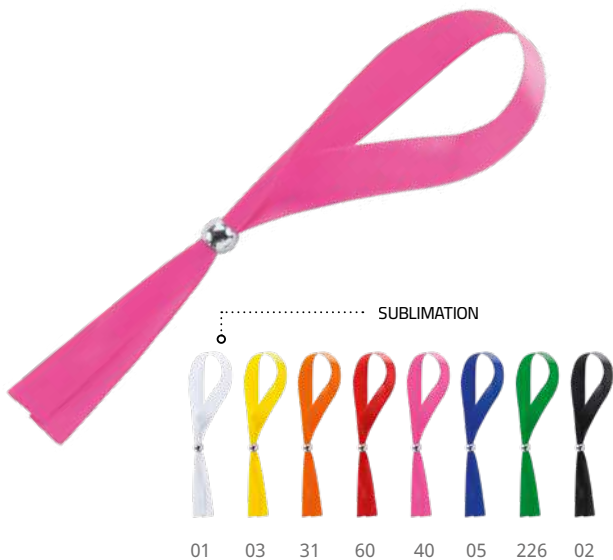

3102 **Fete**

Pulseira ajustável em poliéster.

34,5 x 1,2 cm 50/500 2000

D(1), R



BAMBOO

3098 **Orbit**

Pulseira de algodão natural com feche de segurança (não retornável) em bambú.

35 x 1,5 cm 100 2000

D(1)

FOR ALL
EVENTS



3094 **Drilo**

Pulseira para eventos em fibra sintética com numeração individual. Apresentação em folha de 20 unidades.

25,4 x 1,9 cm 1000 20000

A(1)

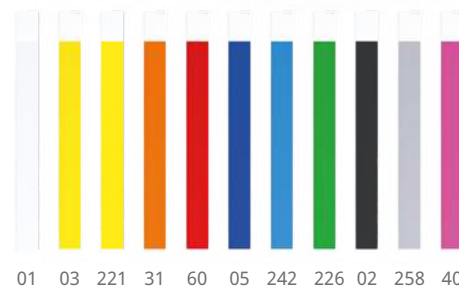

3100 **Party**

Pulseira para eventos em fibra sintética com numeração individual. Apresentado numa grelha com 10 unidades.

25,8 x 2,7 cm 10/1000 20000

A(1)

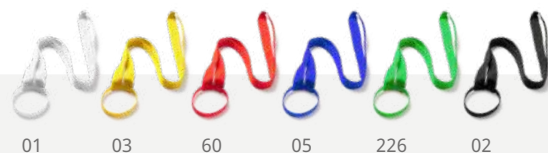
**NEW.**

01 03 60 05 226 02

7047 Aldaz

Suporte de cordão de copo com banda de silicone ajustável.

45 x Ø6 cm

10

1000

F(1), N(8), R

500 ml

4210 Pontal

Copo reutilizável em capacidade resistente dúctil PP. 500 ml.

11,6 x Ø9,2 cm

25

500

C(1)

NEW.**NEW.**

01 60 05 226 02

7046 Dalvik

Cordão de silicone com suporte para celulares ou cartões, sistema de ajuste e mosquetão.

58 x 7 cm

10

300

G(1)



NEW.



7043 **Sumba**

Cordão com acessório retrátil. Mosquetão incluído.

55 x 1 x 3,2 cm 10 500
 D(1), G(1), N(8), R, V



NEW.

4209 **Doki**

Porta-chaves rollerclip com mosquetão e anel retrátil.

12,5 x 1,5 x 3,2 cm 1/100 800
 C(4), V





7054 **Guest**

Correia para chaveiro em poliéster com mosquetão, fivela e trava de segurança.

2 x 55 cm

10/100 600

F(1), N(8), R

CHOOSE YOUR LANYARD



7044 **Nela**

Cordão de algodão com mosquetão, fivela e fecho de segurança.

52 x 2 cm

10

500

F(1), N(8)



NEW.



7052 **Roomer**

Correia para chaveiro em algodão com mosquetão.

2 x 50 cm

10/100 800

F(1), N(8)

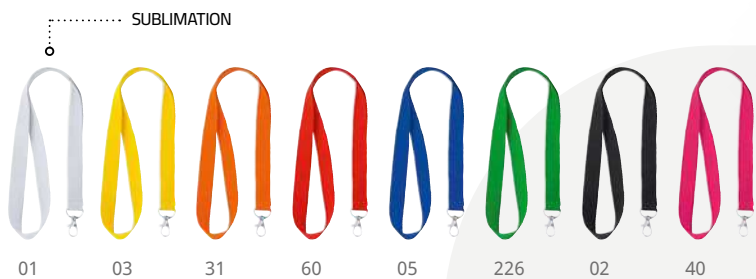

7055 **Ecohost**

Correia para chaveiro em RPET com mosquetão.

2 x 50 cm

10/100 800

F(1), N(8), R

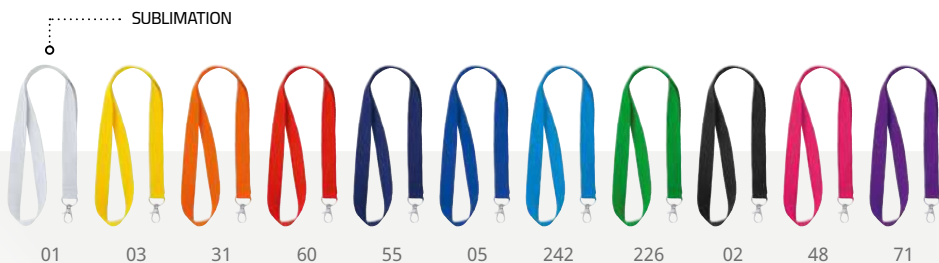

7053 **Host**

Correia para chaveiro em poliéster com mosquetão.

2 x 50 cm

10 800

F(1), N(8), R



NEW.**7045 Pomel**

Cordão com mosquetão correspondente e porta-crachá em PVC.

58 x 11 cm

10

1000

B(1), F(1)

NEW.**7068 Tabor**

Suporte de emblema de PVC transparente em design vertical.

12,1 x 8,4 cm

200

2000

C(1)

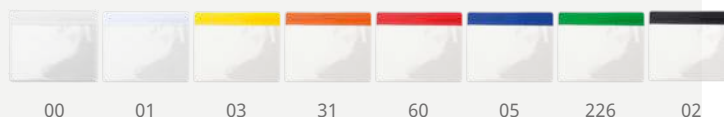
**7070 Bash**

Identificador transparente. PVC.

11 x 9,5 cm

10/100 1000

C(1)

NEW.**7069 Ganda**

Suporte de crachá com frente de alumínio. Pino de segurança duplo.

6,8 x 3,4 cm

1/100

1000

C(4), L1



100% CUSTOMIZABLE ON REQUEST



MINIMUM 250PCS



4124 **Kendal**

Chaveiro com alças de poliéster, específico para sublimação.

 12 x 2 cm



7071 **Sinatra**

Cordão duplo de poliéster com mosquetão, específico para sublimação.

 100 x 2 cm



7049 **Elvis**

Lanyard de poliéster com mosquetão especial para sublimação.

 50 x 2 cm

SUBLIMATION FULL COLOR INCLUDED



3097 **Areta**

Pulseira ajustável de poliéster especial para sublimação.

 30 x 1,5 cm



SECURITY CLASP

3095 **Spring**

Pulseira de poliéster ajustável, específica para sublimação.

 30 x 1,5 cm



3096 **Paradis**

Pulseira de poliéster sem fecho de pressão, específica para sublimação.

 30 x 1,5 cm

SUMMER

NEW BARI

RPET TRANSLUCENT SUNGLASSES



01

60

05



226

02



RECYCLED
PET

8105 Bari

Óculos de sol clássicos com um design de acabamento translúcido. Proteção UV400.

 14 x 4,5 cm

 1/10

 300

 D(2)

NEW.





02

01



8104 **Eden**

Óculos de sol de design atrativo com armação em acabamento brilhante e hastes de bambu natural. Lentes de proteção UV400.

14,5 x 5 cm

1/10

300

D(2), L1



245

248

257



237

999

8102 **Dax**

Óculos de sol clássicos com acabamento em efeito madeira e proteção UV400.

14,5 x 4,9 cm

1/10

300

D(2)



SUBLIMATION



01

03

31

60

05

226

02

40

8110 **Cloud**

Caixa para óculos com cordões de fecho automático. Poliéster com toque macio.

9 x 18 cm

50

1000

D(1), N(8), R





8100 Brista

Óculos de sol clássicos com acabamento brilhante e proteção UV400.

14,5 x 4,9 cm 1/10 300 D(2)



8103 Ariel

Óculos de sol com armação em acabamento mate e lentes de proteção UV400.

14,5 x 5 cm 1/10 300 D(2)



8101 Ciro

Óculos de sol clássicos com acabamento preto mate e lentes espelhadas. Proteção UV400.

14,5 x 4,9 cm 1/10 300 D(2)

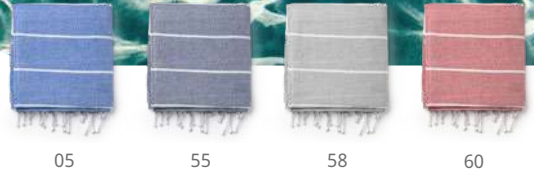

7096 **Denia**

Toalha/Sarongue 100% de algodão 180 g/m².

180 x 90 cm 1 50

F(1), N(8), O, P



7100 **Orly**

Toalha de banho e praia. Rematada com filamento de poliéster de 3 fios no mesmo tom, excepto na cor chumbo escuro (46) que é rematada em amarelo flúor (221). Adorno elástico para enrolar.

S 38 x 68 cm 10 100
 M 60 x 145 cm 10 50
 F(1), N(8), O, P, R



2SIZES



6999 **Bobin**

Gorro de lã estilo bob 100% algodão.

32 x Ø60 cm

50

200

F(1), N(8), O, P



8150 **Kalay**

Chinelos de praia com sola em PE confortável e tiras em PVC. Tamanho 36-38, 42-44.

26 x 1,3 x 9,5 cm

10

60

D(1), E(1)

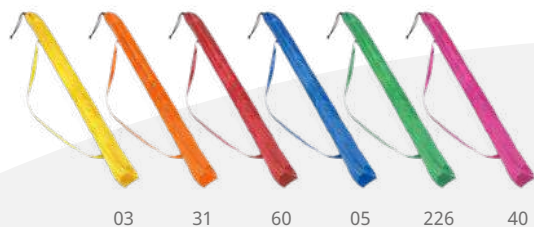

1006 **Skye**

Guarda sol de 8 painéis, produzido em nylon. Proteção UV interior e bordas debruadas. Inclui manga de transporte com asa para o ombro.

100 x Ø155 cm

1

12

H(1), N(8)

UVPROTECTION



1022 **Calon**

Frisbee de design clássico e resistente PP.

1,8 x Ø23 cm 1/100 200
D(1)

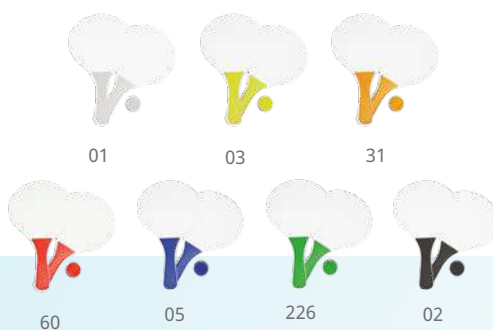

1003 **Feroe**

Raquetas de praia fabricadas em madeira com cabo reforçado colorido. Inclui a bola de jogo. Apresentação em saco de rede.

18,5 x 33 x 0,6 cm 1 30
F(1)



2150 **Saona**

Bola insuflável em PVC. Vazia: 37cm. Cheia: 28cm

Ø28 cm 10/100 200
F(1), G(1)



6L

4121 **Kinto**

Balde de metal com alça. Inclui abridor de alumínio.
Capacidade 6L.

18,5 x Ø23 cm  1  20

 G(1)

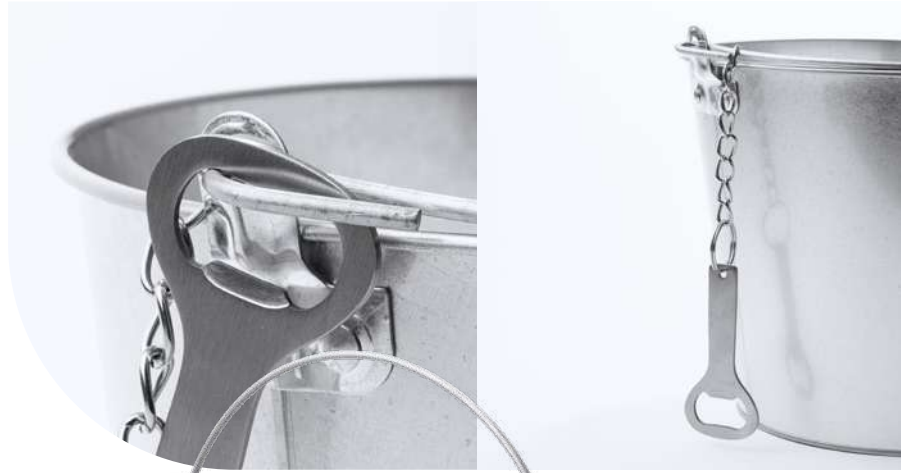

NEW.

NEW LAMBIC



01

60

05

226

02

6L

4208 **Lambic**

Balde de cor metálica com abridor de garrafa de alumínio
incluído. 6 litros de capacidade.

18,5 x Ø23 cm  1  20

 G(1)





8202 **Eider**

Porta utensílios impermeável em PVC adequado para ecrãs táteis.

9,5 x 23 cm 1/50 500 E(1)



1023 **Cenix**

Cinzeiro de bolso com interior de alumínio retardador de chamas. Fechamento de aba com botão.

8 x 1,1 x 8 cm 1/50 500 C(1)



8205 **Lanka**

Grande mala de transporte à prova d'água de PVC adequado para telas tácteis.

12,5 x 23 cm 1/50 300 E(1)



DRY BAG



01

60

05

2,5L

7531 Aleta

Saco impermeável antirrasgões durável. Janela prática com bolso para telemóvel. Sistema de fecho estanque com clique e mosquetão para transporte. Capacidade total: 3L. Capacidade útil: 2,5L.

29,5 x Ø11,5 cm 1/10 200

F(1)



01

60

05

5L

7532 Monje

Saco impermeável antirrasgões durável. Sistema de fecho estanque com clique e mosquetão para transporte. Capacidade total: 8,5L. Capacidade útil: 5L.

35 x Ø18 cm 1/10 100

F(1)



60

05

02

10L

7533 Manati

Saco impermeável antirrasgões durável. Sistema de fecho estanque com clique. Mosquetão e alça de ombro ajustável para transporte. Capacidade total: 15L. Capacidade útil: 10L.

45,5 x Ø20,5 cm 1/10 100

F(1)

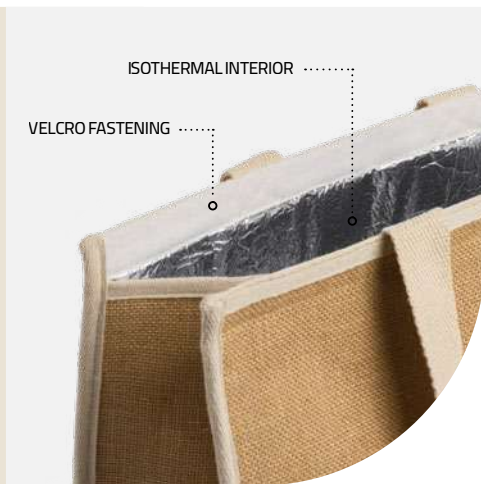

7161 Venice

Bolsa térmica de juta laminada. Interior isotérmico de alumínio com fecho de velcro. Bolso frontal e alças em algodão natural.

43 x 20 x 34 cm 10 40

F(1), N(8)

NEW.



03 60 05 226 02

7197 Lubin

Saco refrigerador dobrável em poliéster 190T. Forro de alumínio isotérmico e fecho de correr. Alças reforçadas. Fácil de dobrar com fecho.

45 x 36 x 9 cm 1/20 100

G(1)



01 31 60 05 226

7603 Tibu

Mala refrigeradora com interior em alumínio isolado para 6 latas. Exterior em PVC durável. Alça de transporte a condizer e fecho de correr.

21 x 15 x 15 cm 1/25 200

F(1), N(8)



10

05

47

7088 Sakra

Mochila refrigeradora em poliéster antirrasgões 210D. Forro isotérmico nos bolsos principal e frontal. Compartimento com cordão elástico frontal e bolsos laterais em rede. 20 litros de capacidade. Alças acolchoadas para os ombros e costas.

26 x 40 x 19 cm  1  10

 G(1), N(8)

NEW.



NEW.



55





02

RECYCLED
PET

7089 Lombok

Mochila refrigeradora em PET. Forro isotérmico no compartimento principal e bolso na aba. Bolsos laterais em rede. 19 litros de capacidade. Alças para os ombros e costas acolchoadas.

30 x 43 x 15 cm  1  20

 G(1), N(8)



05

226

02

40

01

03

31

60

7604 Graja

Mochila refrigeradora com cordões e interior em alumínio isolado. Exterior em poliéster 210D.

32 x 42 cm  1/10  200

 F(1), N(8)



LEISURE & SPORT



60

05

02

7095 **Vulcan**

kit de bengalas dobráveis em alumínio com sistema de amortecimento. Punho ergonômico e faixa de segurança ajustável. Inclui acessório para neve. Superfície reforçada de contato com o solo. Apresentação em prática bolsa de transporte com faixa para ombros.

140 x Ø cm 1 20

G(1), L2, N(8)

3 ACCESSORIES





7093 **Regina**

Corda de pular em algodão com alças de madeira lisas. Apresentação em bolsa de algodão.

280 x Ø2,70 cm 1 50

D(1), L2, N(8)



FITNESS MOOD



7094 **Rocky**

Corda de pular técnica ajustável. Inclui capa para guardar com cordões.

300 x 14,5 cm 1 100

G(1), N(8)



7097 Emon

Conjunto de bandas elásticas para fitness com diferentes resistências. Caixa em poliéster. Bandas de látex.

9 x 21 cm

1/20

100

F(1), N(8)



HIGH INTENSITY

SOFT

MEDIUM

HARD

3 LEVELS

YOGA LOVED

CARRY POUCH



60

05

02

7102 Chakra

Tapete de ioga em EVA macio e leve. Inclui bolsa prática.

 180 x 60 cm

 1

 20

 G(1), K(1)



NEW AURA

NEW.



NATURAL
CORK

7092 **Aura**

Tapete de ioga em cortiça natural, com base antiderrapante e alça de transporte.

 60 x 180 cm

 1

 10

 G(1), N(8), L2



NEW.



03

60

05

226



9322 Dalic

Camisa sem mangas desportiva em poliéster 190T. Alças elásticas laterais com fixação em velcro.

63 x 52 cm

1/25

300

F(1)

SPORT ACCESSORIES

NEW.



01

60

05

02

2151 Tuchel

Bola de futebol tamanho 5 em imitação de couro. Design de duas cores.

Ø21,50 cm

1

40

G(1)



NEW.

3093 Yuma

Pulseira auto-ajustável de alta visibilidade em PVC.

30 x 2,9 cm

1/50

1000

D(1)



REFLECTIVE BAND



POCKET



01

03

60

05

226

02

7105 Speed

Braçadeira elástica fabricada em micro fibra macia. Bolso incorporado com fecho de correr.

10 x 9 cm

1/100

1000

E(1), N(8), R



22102

7802

22302

02221

02221

7118 Marathon

Cinto de running com bolso extensível. Tecido elástico. Fecho de correr reflector e fecho de cintura em plástico. Cintura ajustável.

23 x 5,5 cm

10/10

200

N(8)

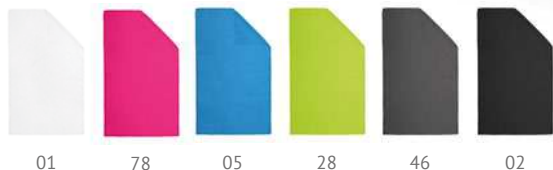

7119 **Cork**

Toalha multidesporto em microfibra. Leve, compacta e fácil de transportar. Rematada com filamento de poliéster com 3 fios no mesmo tom. Secagem rápida. Adorno elástico para enrolar.

70 x 120 cm 10/10 100
 F(1), N(8), O, P, R

STOWAWAY POUCH



7103 **Bay**

Toalha absorvente produzida em micro fibra 345 g/m². Inclui manga reutilizável em PVC

45 x 30 cm 1 100
 F(1), N(8), O, P, R



7101 **Calpe**

Toalha com efeito refrescante em microfibra. Apresentado num prático estojo com mosquetão. Toalha 30x30 cm.

13 x 5,4 x 3 cm 1/50 200
 G(1), N(8)

CARRY POUCH



7057 **Kelsey**

Toalha absorvente produzida em micro fibra 185g/m². Inclui bolsa de acondicionamento com fecho ajustável.

100 x 50 cm 1 100
 G(1), N(8), O, P, R

CROSSFITTER



9001 Crossfitter

Fita running transpirável para a cabeça. Tecido duplo de poliéster. Personalizável.

22,5 x 8 cm 10/10 300

F(1), N(8)

OLYMPIA

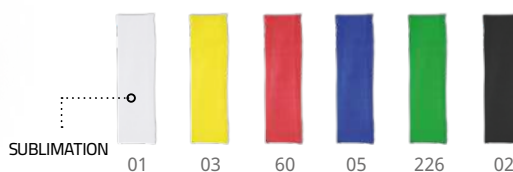

7104 Olympia

Fita elástica desportiva para a cabeça, produzida em micro fibra suave.

23,5 x 6 cm 1/100 800

G(1), N(8), R

WIZER



SUBLIMATION



7048 Wizer

Viseira esportiva de poliéster. Com feche de velcro e laterais alcochoados.

F(1), N(8), O, P, R 25 200



NEW **KARIN**

NEW.



01

60

05

55

02

7026 **Karin**

Tampa desportiva respirável em 100% microfibra, com 6 painéis. Fixação de fivela ajustável e ilhós de ventilação. Etiqueta removível.

 25  200

 F(1), N(8), O, P, R

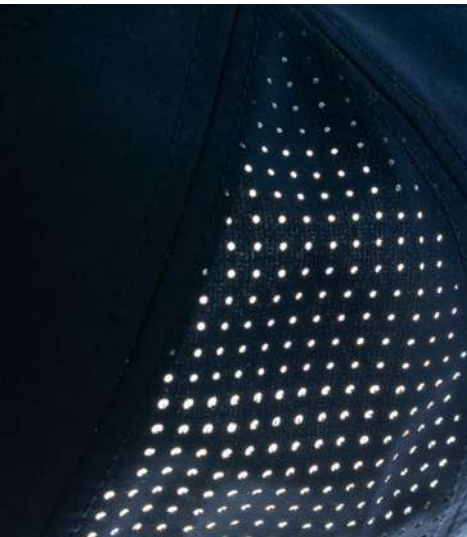

01

221

234

05

02

7020 **Mercury**

Chapéu de 3 painéis, transpirável e de secagem rápida. Tecido técnico leve. Fecho ajustável em velcro na parte posterior.

 25  200

 F(1), N(8), O, P, R

NEW.

221



223

7033 Balder

Tampa de 5 painéis em 100% poliéster com detalhes de alta visibilidade. Fixação de velcro ajustável e ilhós de ventilação. Etiqueta removível.

☐ 25 📦 200
 👤 F(1), N(8), O, P



01



55

7023 Iberis

Tampa de 5 painéis em 100% algodão. Design com a bandeira nacional. Fixação de velcro ajustável e ilhós de ventilação. Etiqueta removível.

☐ 25 📦 200
 👤 F(1), N(8), O, P

NEW.

100% RECYCLED PET



7000 **Basica**



Chapéu de 5 painéis e 2 furos de ventilação bordados. 4 costuras pespontadas na pala. Cinta interior anti-suor. Fecho ajustável em velcro na parte posterior.

 25
  300
 Consultar



7050 **Calisto**

Boné de 5 painéis com pala em contraste. 6 linhas de costura na viseira. Quatro furações de ventilação. Fita anti-suor interna. Fecho com velcro.

 25/75
  300
 F(1), N(8), O, P, R



NEW.

NEW FREYA



7030 Freya

Tampa de 5 painéis em 100% algodão. Fixação de velcro ajustável e ilhós de ventilação. Etiqueta removível.

Ø59,00 cm

30

300

F(1), N(8), O, P

100% COTTON



NEW.



7024 **Tarvos**

Tampa de 5 painéis em 100% algodão. Fixação de velcro ajustável e ilhós de ventilação. Etiqueta removível.

25 200
F(1), N(8), O, P



01



05



226



02



7009 **Fides**

Tampa de 5 painéis em 100% algodão. Fixação de velcro ajustável e ilhós de ventilação. Etiqueta removível.

25 200
F(1), N(8), O, P

NEW.



Kids



01

Kids



03

Kids



60



55



05

Kids



226



02

7041 **Uranus**

Chapéu de 5 painéis e 2 furos de ventilação. 4 costuras pespontadas na pala. Cinta anti-suor no interior. Fecho ajustável em velcro na parte posterior.

25 300
F(1), N(8), O, P



7012 Terra

Chapéu de 6 painéis e 2 ilhosos metálicas em cada lado. 6 costuras pespontadas na pala. Cinta anti-suor e parte inferior da pala em contraste. Fecho ajustável metálico na parte posterior.

25 200
F(1), N(8), O, P



7008 Panel

Chapéu de 6 painéis "sandwich". 6 furos de ventilação bordados e botão no topo a contrastar. 6 costuras pespontadas na pala. Cinta anti-suor no interior. Fecho ajustável em velcro na parte posterior.

25 200
F(1), N(8), O, P



7019 Eris

Chapéu de 5 painéis "sandwich" a contrastar. 4 furos de ventilação. 6 costuras pespontadas na pala. Cinta anti-suor no interior. Fecho ajustável em velcro na parte posterior.

25 200
F(1), N(8), O, P



PERSONAL CARE

NATURAL
CORK

NEW.

1126 **Podox**

Kit de manicure com caixa de cortiça e fecho de pressão. Tesoura de aço inoxidável, pinças, cortador de unhas, lima e cortador de cutículas incluído.

11 x 6 x 2 cm 1/50 200

E(1), L1, N(8)



PEDICURE ACCESSORIES



NEW.

1125 **Velvet**

Kit de manicure numa bolsa de algodão com cordão. Lima de unhas e aparador incluídos.

12 x 7,8 cm 1/50 400

F(1), L1, N(8)





NEW.

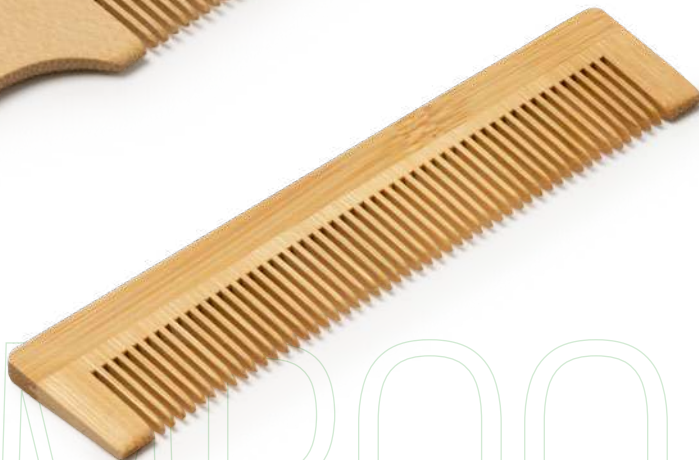

NEW.

BAMBOO



BAMBOO



1215 **Rizo**

Pente de bambu com cabo. Apresentação em caixa de design ecológico.

 3,5 x 18,4 x 0,6 cm

 1/100  500

 C(4), L1



BAMBOO



1214 **Kurly**

Pente de bambu. Apresentação em caixa de design ecológico.

 13,8 x 3 x 0,6 cm  1/100  500

 C(4), L1



NATURAL
CORK1231 **Belle**

Espelho de bolso dobrável feito de cortiça natural e metal cromado, consistindo em dois espelhos, um normal e um de ampliação. Apresentação em caixa de design ecológico.

2 x Ø6,10 cm 1/50 200

C(4), L1, W

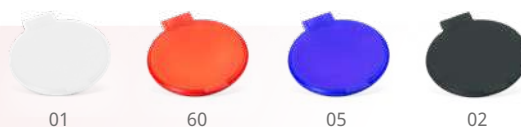

2X

1220 **Glaze**

Espelho de bolso prático e dobrável com cobertura em PP translúcido.

0,5 x Ø6 cm 1/50 500

C(4), W

1223 **Liner**

Espelho duplo, normal e de aumento. Tampas macias de PU e fecho magnético.

0,9 x Ø7 cm 1/50 300

C(4), L1, W

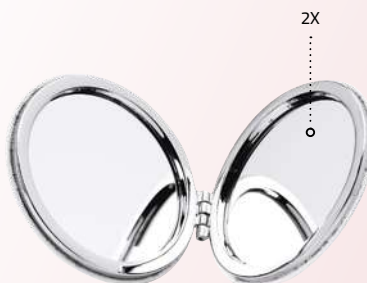

2X

1221 **Blunt**

Escova prática e dobrável com espelho, em formato de bolso. Fabricado em PP maciço.

2,3 x Ø6,60 cm 1/50 200

C(4)



251



281



260

NEW.

1216 **Dumai**

Escova de cabelo desembaraçante prática com um design de acabamento brilhante.

6,7 x 4,5 x 9 cm 1/50 200

D(1)

BEAUTIFUL PURSES

NEW.



251



281



260

7570 **Mauve**

Bolsa em PU com um design de acabamento brilhante, com fecho de correr e puxador a condizer.

12 x 8,5 x 0,5 cm 1/10 1000

D(1)



251



49



260

1225 Beiso

Batom protetor em invólucro esférico com acabamento cromado. Proteção SPF15

Ø3,80 cm

1/50

500

C(1)



LIP BALMS



WHEAT FIBER

1230 Lapp

Batom protetor em invólucro clássico, em forma cilíndrica e produzido em fibra de trigo. Proteção SPF15

7 x Ø1,90 cm

1/25

500

C(1)



01

03

31

60

40

05

226

1124 Lissen

Batom protetor em invólucro clássico, em forma cilíndrica e acabamento translúcido. Proteção SPF15

7 x Ø1,90 cm

1/25

500

C(1)



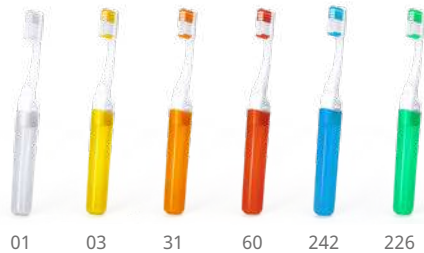

9924 **Pole**

Escova de dentes dobrável em PP com cerdas macias.
Ideal para viajar.

17,5 x 2,3 x 1,5 cm

1/50 500

C(1), W

CHOOSE
YOUR
COLOR



9944 **Clive**

Escova de dentes com divertido corpo colorido e acabamento suave, com ventosas na base para fixação.

14,5 x 1,5 x 2,7 cm

1/50 500

F(1), L1



03

31

60

05

226



01

60

05

226

9945 **Kora**

Escova de dentes com corpo PLA. Cerdas brancas macias. Apresentação em caixa ecológica.

18,4 x 1,6 x 1,4 cm

1/100 600

C(1)



BAMBOO

9923 **Fresh**

Escova de dentes com corpo em bambu e cerdas brancas macias. Livre de aditivos BPA e 100% biodegradável. Apresentação em caixa design de papelão kraft.

17,5 x 1,6 x 1,3 cm

1/50

400

C(4), L1

BIO DEGRA DABLE



FUNNY TOOTHBRUSH



03

60

05

226

9946 **Mesler**

Conjunto de escova de dentes e ampulheta. Escova de dentes com divertido corpo colorido e acabamento liso, com ventosas na base. Ampulheta de 2 minutos de duração. Apresentação em caixa individual com fecho hermético.

19,5 x 8,5 x 2,5 cm

1/10

200

F(1), L1

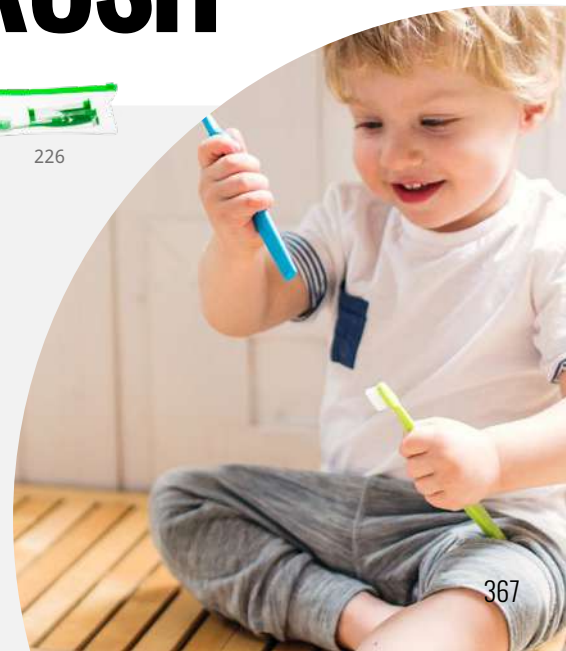



9919 **Nobel**

Lenço higienizante hidroalcoólico de uso único e compostável. Álcool a 70%. Embalagem individual selada termicamente

📏 5,7 x 8 cm 📦 1/100 📦 3000
👤 A(1)



50ml

9907 **Gilman**

Gel desinfetante para as mãos. Frasco prático de 50 ml. Álcool 70%.

📏 4,5 x 8,5 x 2,9 cm 📦 50 📦 200
👤 C(1)

SANITIZING GEL



10ml

9908 **Varmus**

Gel higienizante de mãos com 70% de álcool. Recipiente prático de 10 ml translúcido e pulverizador tipo spray. Tampa com clip disponível em várias cores.

📏 12,6 x Ø1,60 cm 📦 1/50 📦 500
👤 B(4)



30ml

9906 **Bishop**

Gel higienizante de mãos com 70% de álcool. Recipiente prático de 30 ml com mosquetão.

📏 3,5 x 10 x 2,2 cm 📦 1/50 📦 200
👤 C(1)



30ml

9934 **Genzel**

Gel higienizante de mãos de 30ml, com pulverizador tipo spray.

📏 10,1 x Ø2,70 cm 📦 1/100 📦 200
👤 C(1), W

ORGANIZERS



1227 Medy

Caixa prática em PP para comprimidos, com 2 compartimentos e acessório de corte.

9,5 x 1,6 x 4,8 cm 1/100 400

C(4), W

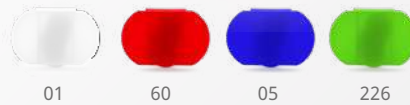

1226 Citos

Caixa para comprimidos em PP com três compartimentos. Design com acabamento translúcido.

6 x 1,3 x 3,9 cm 1/100 1000

C(4), W



+ antibacterial
ISO 22196

1222 Drop

Caixa de comprimidos com 3 separadores, produzido em PP com tratamento anti-bactérias.

6 x 1,3 x 3,9 cm 1/100 1000

C(4), W

STRESS BALLS



NEW.



1232 Dona

60 05

Bola de tensão em forma de gota em PU de cor lisa.

8 x 0,5 x Ø6 cm 1/20 400

E(1)

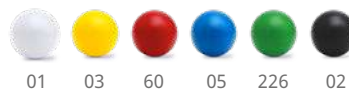

1228 Seyku

Bola anti-stress em PU de cor sólida.

Ø6,20 cm 1/20 400

E(1)



NEW.
COLOR



1229 Biku

60 01

Coração anti-stress em PU de cor lisa.

7 x 7 x 4 cm 1/20 400

E(1)



55

258

02

8201 Ansar

Almofada insuflável ideal para viajar com uma sensação de camurça suave.

33 x 9 x 25 cm 1/20 200

F(1)



8200 Branta

Máscara de viagem feita em microfibra macia. Ajuste elástico duplo.

18,5 x 9 cm 1/100 1000

D(1), N(8)



01

02



8151 Yllier

Sapatilhas unisexo produzidas em algodão / poliéster cómodo, com interior acolchoado. Inclui bolsa prática em no woven. Tamanho único 36 - 43.

11,5 x 29 x 1,7 cm 1/10 200

E(1), N(8)

TIME TO RELAX

NEW.



03

60

40

05

226

8199 Noys

Tampões de ouvido em espuma EVA. Apresentação em estojo com corrente de transporte.

6,4 x Ø2,20 cm 1/200 1000

C(1)



02 55 05 60 226

7182 Oblak

Saco de sapatos em poliéster 600D. Alça prática para transporte incluída.

35 x 15 x 16 cm 1/25 100

F(1), N(8), O

NEW.



9935 Arnold

Estojo de viagem transparente produzido em PVC com fecho hermético. Inclui sortido de recipientes práticos ideais para gel, champô e perfume.

19 x 19 cm 1 100

F(1)

NEW.



2991 Covas

Alarme pessoal, ativado pela separação do conector ligado ao porta-chaves. Apresentação em caixa de design.

3,9 x 6,1 x 1,9 cm 1/50 300

D(4)



01 03 31 60 40 05 226

7511 Caribu

Estojo de toilette com fecho hermético em PVC translúcido.

17 x 13 x 5 cm 1/50 400

F(1)



01
60
05
02

9939 Strickland

Bolsa de PVC multiusos. Corpo transparente com fecho de cor. Ideal para guardar todo o tipo de máscaras.

20 x 12,5 x 0,25 cm 20 1000

E(1)



NEW.



NEW.



7497 Naro

Saco de toucador multifuncional em 100 % algodão Fairtrade (180 g/m²). Bolso principal com fecho de correr e puxador a condizer.

21 x 13 x 8 cm 10 100

F(4), N(8), O, P



7498 Zigari

Saco de toucador multifuncional em 100% algodão Fairtrade (180 g/m²). Bolso principal com fecho de correr e puxador a condizer.

23 x 17 x 6 cm 50 300

F(4), N(8), O, P



7537 Doel

Saco multiusos em algodão de 280 g/m² com acabamento bicolor. Fecho de correr com puxador em algodão a condizer.

22,5 x 17 x 5,5 cm 1/50 300

F(1), N(8)



7558 **Sierra**

Bolsa de higiene multiusos em algodão 180 g/m² e sarapilheira. Fecho zíper com puxador de em sarapilheira a combinar

21,5 x 16 x 5 cm 10 200

F(1), N(8)

7564 **Siena**

Bolsa de higiene feita em algodão e juta laminada. Zíper com puxador de juta combinando.

21 x 11 x 6 cm 1/50 200

F(1), N(8)



YUTE NATURAL

7563 **Vera**

Bolsa toallete feito de algodão e juta laminada.

20 x 15 x 6 cm 1/50 200

F(1), N(8)



NEW.



01

02



05



226



60



RECYCLED
PET

7547 **Bubo**

Estojo de banho com dois compartimentos com fechos e asa de transporte a combinar. Produzido em poliéster reciclado RPET 210D.

21 x 13 x 8 cm 1/20 100

F(1), N(8), O

RECYCLED PET

NATURAL HEMP



261



152



02



HEMP

7499 **Prado**

Saco de toucador multifuncional em tecido cânhamo (200 g/m²), com alça correspondente.

21 x 13 x 8 cm 1/10 100

F(1), N(8)



7514 **Yubarta**

Estojo de toilette em poliéster 600D. Fecho de correr com puxador a condizer.

 22 x 14 x 6 cm  10  300

 F(1), N(8), O

7565 **Sedna**



Bolsa multiusos em poliéster 600D. Fecho com zipper a condizer.

 22 x 14 x 6 cm  1/20  300

 F(1), N(8), O

7513 **Pardela**

Estojo de toilette em poliéster 600D com fecho de correr e alça de transporte conveniente.

 20 x 10 x 8 cm  1/10  200

 F(1), N(8), O



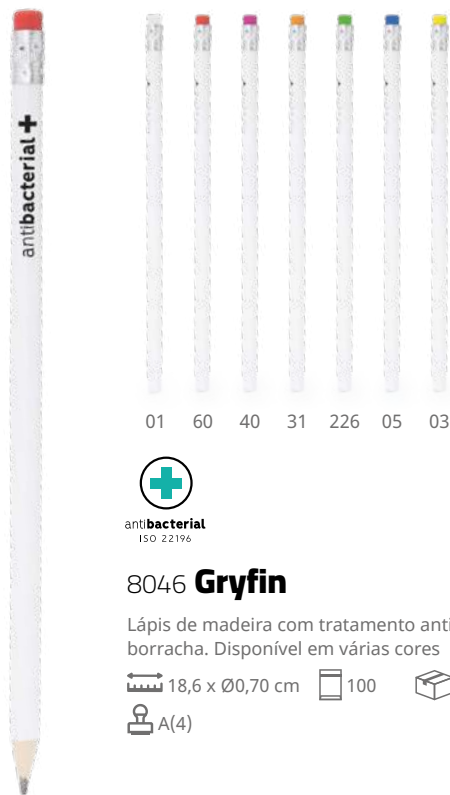

01 60 40 31 226 05 03



antibacterial
ISO 22196

8046 Gryfin

Lápis de madeira com tratamento anti bacteriano e borracha. Disponível em várias cores

18,6 x Ø0,70 cm 100 2000

A(4)



01 60 05 02



antibacterial
ISO 22196



TOUCH
PEN

8022 Farber

Esferográfica higienizante anti bacteriana multifunções, com pulverizador recarregável e ponteiro táctil. Capacidade 3 ml (líquido não incluído). Tinta azul

16 x Ø1,50 cm 1/50 1000

B(4)

ANTIBACTERIAL



ELION8061

WATSON8060



antibacterial
ISO 22196

8060 Watson

Bloco de notas A5. Capas em PU com tecnologia antibacteriana. Marcador e elástico. 100 folhas. Padrão ISO 22196.

14,9 x 21 x 1,4 cm 1/25 50

E(4)



antibacterial
ISO 22196

8061 Elion

Bloco de notas A6. Capas em PU com tecnologia antibacteriana. Marcador e elástico. 80 folhas. Padrão ISO 22196.

9 x 14 x 1,4 cm 1/50 100

E(4)

+ antibacterial

ISO 22196



antibacterial
ISO 22196

8040 **Stark**



Caneta esferográfica com corpo em ABS. Antibacteriana. Tinta azul. Padrão ISO 22196.

13,8 x Ø1 cm 1/50 1000

A(4)



antibacterial
ISO 22196



TOUCH
PEN

8015 **Hallerbos**



Caneta com corpo em ABS antibacteriano e ponteiro tátil. Clipe em metal e carga jumbo com tinta azul. Padrão ISO 22196.

13,9 x Ø1 cm 1/50 1000

A(4)



ANTIBACTERIAL



03 31 60 05 226 02



antibacterial
ISO 22196

8039 **Carrel**



Caneta esferográfica com corpo em ABS antibacteriano e pega translúcida e macia. Tinta azul. Padrão ISO 22196: 2011.

14 x Ø1,30 cm 1/50 1000

A(4)



antibacterial
ISO 22196

8038 **Newton**



Caneta esferográfica com corpo em ABS antibacteriano. Tinta azul. Padrão ISO 22196: 2011.

14 x Ø1,30 cm 1/50 1000

A(4)



CHRISTMAS



4012 **Berry**

Caneca cerâmica com acabamento mate e tampa de bambu natural. Capacidade de 370ml. Apresentação em caixa de cartão kraft.

10,5 x Ø8,20 cm



F(1), L2

A TOUCH OF NATURAL INSPIRATION

CORK | GLASS | BAMBOO



1313 **Surna**

Vela aromática em recipiente de vidro com tampa de cortiça. Fragrância de baunilha. Cartão kraft para impressão incluído. Apresentação em caixa de design ecológico.

7,6 x Ø5,60 cm



(E1)



1315 **Vanila**

Vela aromática em vidro translúcido e tampa de bambu. Fragrância de baunilha. Apresentação em caixa de design ecológico.

8,8 x Ø7,00 cm



E(1), L2





CHALKBOARD



VANILA
SCENT



1307 King

Vela perfumada com recipiente em lousa cerâmica. Inclui giz branco. Apresentação em caixa de papel Kraft.

7,8 x Ø7,00 cm 1 50

E(1), L1

1312 Maka

Vela em suporte de madeira com desenhos de Natal (estrela e árvore). Apresentado em caixa individual.

8,7 x 2,1 x 8,4 cm 1/100 200

E(1), L1



512



511



VANILA
SCENT

1306 Flake

Vela perfumada com cores vivas e combinadas com recipiente de metal. Caixa com tampa transparente.

3 x Ø6,30 cm 1/50 250

E(1), L1



01 260 60 251 02

1311 Kimi

Vela aromática num vaso de vidro de várias cores e fragrâncias (café, pinheiro, lavanda, baunilha e morango). Apresentado em caixa individual.

6,7 x Ø5,60 cm 1 50
F(1), L1

MAKE YOUR BRAND SHINE

PREMIUM COLOURS



251

260

**4024 Zala**

Caneca cerâmica de 350 ml com design de acabamento brilhante. Especial para gravação a laser. Apresentação em caixa branca.

9,6 x Ø8,20 cm 1 36
F(4), L2



1298 **Tinsel**

Árvore de Natal em madeira com uma mensagem.
Suporte removível.

11,5 x 17,7 x 3,1 cm

1/100

400

D(4), L1



512



511



510



514

1305 **Jingle**

Ornamento de Natal em madeira em formatos diversos.
Inclui alça vermelha para pendurar.

9,5 x 10 cm

1/50

400

C(4), L1



512



511

1299 **Rudolf**

Ornamento de Natal em ardósia em dois formatos. Inclui alça para pendurar.

8,5 x 10 cm

1/25

100

C(1)

WELCOME **CHRISTMAS**

514

512

513

1302 **Abend**

Enfeite de Natal em feltro. Disponível em três designs: Floco de Neve, Árvore de Natal e Rena.

10,1 x 8,3 x 0,3 cm

10/100 500

C(1), N(8)

1310 **Carol**

Conjunto de 3 decorações de Natal em feltro: Estrela, Árvore e Alce. Para pendurar em árvore de Natal.

10 x 10 cm

1/100

500

C(1)

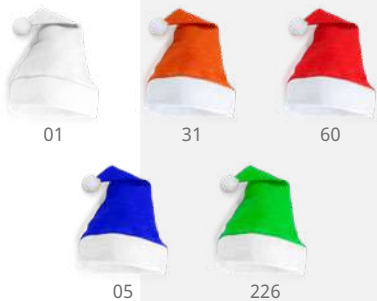

1300 **Santa**

Chapéu de Pai Natal fabricado em poliéster macio. Tamanho único.

43 x 30 cm

/10

200

E(1), N(8)



**FEEL
LIKE
SANTA
CLAUS**



1301 **Noel**

Meia de Natal com alça de suspensão. Fabricado em poliéster suave.

34 x 22 cm

/10

200

E(1), N(8)



CRAYONS INCLUDED

1309 **Nick**

Gorro de Pai Natal para as crianças colorirem. Faixa frontal com desenhos de Natal. 4 lápis de cera incluídos.

41 x 27 cm

1/50

300

F(1), N(8)



1304 **Klaus**

Iman de Natal com desenho do Pai Natal. Inclui bloco de notas com 45 folhas lisas e lápis de madeira.

 20 x 10 cm
  1/50
  200
 C(2)

CRAYONS INCLUDED



1308 **Reno**

Meia de Natal para colorir. Inclui 5 lápis de cera sortidas. Fabricado em tecido não tecido de 80 g / m2.

 29,5 x 19 cm
  1
  200
 F(1)



UNSHARPENED

515

516

512



1303 **Nuss**

Lápis de madeira branca com borracha em desenhos de Natal.

 19 x 2,7 cm
  1/50
  500
 B(4)

MATERIALS

MOST OF THE MATERIALS WE USE IN THE MANUFACTURE OF OUR PRODUCTS ARE NATURAL OR RECYCLED. THANKS TO THIS, IN ADDITION TO CONTRIBUTING TO THE RESPONSIBILITY OF HAVING A MORE SUSTAINABLE WORLD, THESE MATERIALS ALLOW US TO CREATE INNOVATIVE AND VERSATILE PRODUCTS, WITH A VARIETY OF FINISHES AND TEXTURES THAT ADAPT TO ALL TYPES OF SPACES.

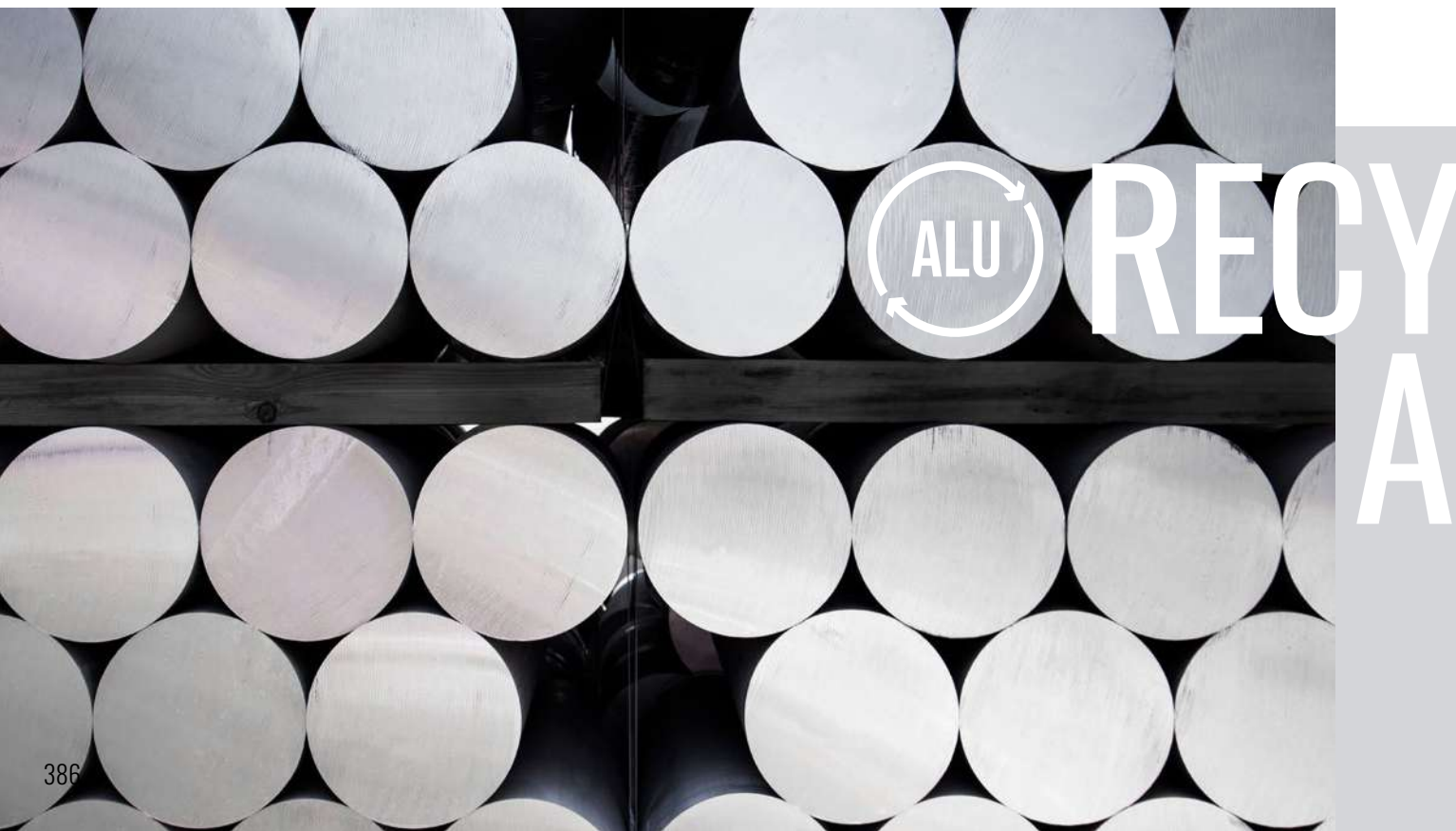

NEW MATERIAL

RECYCLED LEATHER



Leather is one of the oldest, most durable and versatile natural materials available. Thanks to its recycling, we give a new use to those leather residues originating from fashion or from the processing and treatment of the material mostly small pieces of processed leather.



NEW MATERIAL

RECYCLED ALUMINIUM

Aluminium is a highly recyclable material. It is easy to handle, light in weight, does not break, does not burn and does not rust, can be easily compacted, taking up little space. In addition, it can be 100% easily recycled without losing quality.





PLA

Also called polylactic acid, it is derived from natural and renewable raw materials, such as corn, beetroot and other starch-rich products.



LIMESTONE CEMENT



Limestone cement is a conglomerate formed from a mixture of calcined and subsequently ground limestone and clay. Once hardened when in contact with water, it is a very consistent and highly durable material.



NATURAL WOOD



Wood is a timeless and immortal material that fits perfectly with any decorative style, bringing a distinctive touch to the space in which it is placed. In addition to advantages such as strength and durability, natural wood in the home brings a good amount of benefits, including some that act directly on health.



WHEAT FIBER



Wheat fibre is an agro-industrial residue produced during the extraction of cereal grains. Originally used for livestock feed or as fodder, in recent years it has begun to be used as a bioplastic derived from plant origin, helping to reduce the consumption of plastic.





NATURAL JUTE



Known as the 'golden fibre', jute is one of the most widely used natural fibers for various textile applications since ancient times. It is a very strong and durable fibre, with insulating and antistatic properties. It is 100% biodegradable and recyclable and therefore environmentally friendly.

CORK



Cork is an environmentally friendly, biodegradable, recyclable and sustainable material. It is obtained from the bark of the cork oak, which is regenerated every year. It is highly valued for its lightness and strength. It is also a very good insulator. For example, in the form of a yoga mat it blocks the cold that rises from a cold floor. Added to this is its elegant and natural aesthetic.



BAMBOO



Bamboo is a natural, ecological and sustainable material. Due to the rapid growth of the plant, it is a very renewable material. Its advantages are multiple and it is a good alternative to the use of wood. It is known as "Plant Steel" for its resistance to certain stresses and its good seismic behaviour. It is also a very flexible and a lightweight material.

RECYCLED PET



Recycled pet or rPET, is the most recycled material in the world, helping to reduce plastics with which pet bottles are manufactured and offering a new life to their waste. It stands out for being resistant and acting effectively as a protection and barrier against water vapour and oxygen.



BAMBOO FIBER



Bamboo fibre is a natural fibre that is obtained from the filaments of the plant. Its use as an additive in different compounds results in aesthetically attractive products that provide a touch of naturalness.



RECYCLED PAPER

Recycled paper provides a second life to this cellulose fiber mainly from the wood of the trees. In addition, the production of paper from this recycled material and not from cellulose can reduce energy costs by up to 60%.





RECYCLED ABS

Recycled ABS or R-ABS is a tough, durable plastic that does not corrode easily when it comes into contact with abrasive materials. It is the result obtained after the recycling process of the ABS material, helping it not to be wasted and discarded after a single use.



ANTIBACTERIAL

Material treated with silver ions, which prevents the proliferation of pathogenic microorganisms.



TRITAN

Tritan is a new generation of recyclable and health-safe copolyester resins. This material is free from BPA, bps and any other type of bisphenol.





RECYCLED COTTON

Recycled cotton is obtained from used clothing or garment remnants. Its production reduces the amount of energy, water and dyes required. Therefore, it is one of the most sustainable and most respectful fabrics in all its processes.





ORGANIC COTTON

Organic cotton is a cotton that is produced and certified according to organic agricultural standards. It is soft, comfortable, and hypoallergenic. This fabric has the same quality as natural cotton and its cultivation creates a minimum impact on the environment.





NEW MATERIAL



FAIRTRADE COTTON

The products made with certified fair trade cotton guarantees the support of cotton growers so that they improve their quality of life and their communities, contributing to protect people and the environment.





NEW MATERIAL



HEMP

Hemp is considered the most resistant, soft, and durable textile fibre of vegetable origin. Its fabric is one of the oldest and most ecological, it is made from fibers that are extracted from the inside of the stem of the cannabis plant, which is of plant origin and biodegradable. Its great flexibility makes it ideal for making garments and accessories.



NEEDS

INDEX BY PRODUCT / FAMILY

A	
Air freshener	280
Antibacterial notepads	109, 376
Antibacterial pens	79, 89, 377
Anti-theft backpack	127
Aprons	239, 240, 241, 242, 315
Aroma diffuser	262
Apron for colouring	259, 159
B	
Backpack bags	170
Backpacks	302, 123, 124, 125, 125, 126, 127, 128, 129, 130, 145, 146, 147, 148, 149, 150, 151
Backpacks for sublimation	301, 302, 155, 191
Badge holders	329
Bags	301, 303, 166, 167, 168, 169, 170, 171, 172, 173, 174, 175, 176, 177, 178, 179, 180, 181, 182, 183, 184, 185, 187, 188, 189
Bags for Sublimation	301, 303, 190, 191
Ball	287, 350
Ball pens	72, 73, 74, 75, 76, 78, 79, 80, 81, 82, 83, 84, 85, 86, 87, 88, 89, 90, 91, 94
Beach rackets	338
Beach umbrella	337
Belt pouch	136
Blankets	289, 290, 291
Bottle cooler	248
Bottles	211, 213, 214, 215, 216, 217, 219, 220, 221, 222, 223, 224, 225, 228, 229, 230, 231, 232, 233, 234, 235, 236, 237, 304, 305, 306
Bottles for sublimation	223, 228, 304, 305
Bracelets	313, 324, 331
Brush with mirror	363
Bucket	339
Backpack for colouring	259, 159
Bag for Colouring	259, 159
C	
Calendars	116
Candles	262, 263
Caps	314, 354, 355, 356, 357, 358, 359
Car truck organizer	280
Carpenter's pencil	95, 273
Cases	97, 115
Charger desk tray	31
Charger holder	32, 37
Charger mat	19, 40
Chargers 3 in 1	29, 59
Charging Watch	22, 23
Cheese set	246
chopping board	245
Christmas decorations	136, 137

Christmas decorations set	137
Christmas hat	138
Christmas pencils	139
Christmas socks	138
Clappers	305, 321
Coaster	247
Cocktail shaker	253
Cocktails set	252
Colour pencils	99
Comb	362, 364
Cooler backpack	343, 160, 161, 163
Cooler bags	342, 160, 177, 207, 342, 161, 162, 163, 164
Colour crayons	98
Corkscrew	249
Cotton backpacks	145, 152, 153, 154, 155
Cotton bags	166, 168, 169, 170, 171, 172, 173, 174, 175
Cup	193, 200, 201, 208, 209, 210, 213, 227, 236, 306, 325
Cup for sublimation	193, 306
Cutlery set	204, 205
Cutters	272
Case for colouring	259, 159
D	
Deck of cards	255
Diaries	116
Digital kitchen scale	244
Document bags	124, 130, 131
Drawing set	96, 98, 258
Drawstring backpack	302, 152, 153, 156, 157, 158, 159
Drinking Glass	193, 200, 201, 208, 209, 210, 213, 227, 236, 306, 325
E	
Earphones	16, 25, 28, 39, 42, 43, 50, 51, 52, 53, 54
Earplugs	370, 133
Elastic bands set	347
Endless pen	92, 93
F	
Fairtrade backpack	152
Fairtrade bags	166
Fairtrade toilet bag	138, 139
Fans	322, 323
Flags	321
Flashlights	275
Fleece neckwarmer	293
Flexometer	274
Flip flops	337
Flower pot	260, 261
Foldable bags	176, 186

Foldable bowl	287
Foldable umbrellas	298, 299, 311
Frisbee	287, 338
G	
Glass bottles	Glass bottles
Glasses pouches	Glasses pouches
H	
Ham cover	187
Hat	292, 337, 317, 318, 319
Hat bands	302
Hemp backpack	154
Hemp bags	167
Hemp toilet bag	138
high-visibility wristband	351
Hip flask	253
Hydroalcoholic gels	368
I	
Ice Scraper	281
Inflatable ball	338
Insulated bottles	211, 219, 220, 222, 223
J	
Jumping rope	346
Jute bags	176, 177, 178, 179, 180, 181
K	
Keyring flexometer	268
Keyrings	265, 266, 267, 268, 326
Kitchen cutting board	245
Kitchen mitts	241, 243
Kitchenware set	204, 205
Knit beanie	292, 337
Kitchen towel	240
L	
Lamp Alarm clock	13
Lanyards	313, 325, 326, 327, 328, 330
Laptop pouch	126
Lip balms	365
Luggage tag	135
Lunch boxes	201, 203, 204, 206
M	
Magnetic board	258
Manicure kit with	361, 134
Marker pens	84
Mask holder	371
Measuring cup	253
Mini notebooks	111

Mirrors	363
Mouse pad	19, 62, 63, 312
Mugs	194, 195, 196, 197, 198, 199, 200, 201, 202, 203, 208, 306, 307, 308, 309, 379
Mugs for sublimation	194, 195, 202, 306, 307, 308, 309
Multicolour backpack	155
Multicolour pen	86
Multipurpose bag	144, 145, 173
Multipurpose dry bag	340
Multipurpose folder	100, 101, 102
Multipurpose thermo	226
Multi-Tool Ball pen	94, 272
Multitools	271, 272, 278
Multifunctional belt	351
N	
Neckwarmer hat	293
Notebooks	106, 110, 111, 112
Notepad holder	103
Notepads	103, 104, 105, 106, 107, 108, 109, 110
O	
Opener	249, 251, 267
Organizer	31
P	
Paper bags	182, 183
Pen pouch	91
Pencil case	97, 115
Pencil holder	18, 45
Pencils	95, 273, 376
Perpetual calendars	117
Personal Alarm	371, 132
pet collars	286
Photo frame charger	18, 22
Pill boxes	369
Plug adaptors	60, 132
pocket Ashtray	340
Pointer ball pens	74, 85, 86, 87, 89
Power banks	29, 30, 38, 56, 57
Purses	364, 137
Puzzle	257
R	
Recycling bags set	184
Roller and mechanical pencil	71
Roller pens	72, 77
RPET bags	185
Reversible hat	292
S	
Safety glasses	273

Sandwich holder	165
sanitizing wipe	368
Sarong towel	336
Scale	274
Scarves	320
Seed paper notebook	113
Seed paper notepad	113
Set of games	254
Shoe bag	371, 147
Shoe cleaning kit	134
Skill games	254, 256, 257
skittles set	254
Slippers	370, 133
Smart Watches	55
Smartphone holder	33, 44, 60, 61, 264
Solar power bank	56
Spatula	244
Speaker Charger	37, 41, 42, 47
Spoon	244
Sport Bands	347
Sports camera	56
Sports pinnie	320, 350
Spray pen	79, 376
Sticky notes pad	113, 114
Straws	205
Stress relievers	269, 369
Sublimation braçlets	313, 331
Sublimation Jar	193, 306, 308
Sublimation Kitchen mitts	243, 315
Sublimation Lanyards	313, 330
Sublimation toilet bags	301, 191
Sunglasses	333, 334, 335
Sunshield	283, 284, 285
T	
Table Lamp	14, 20, 26
Table mat	240
Tangram puzzle	257
Thermal blanket	282
Thermo cup	227
Thermos	212, 213, 224, 226, 305
Thick chalk set	98
Thread counting magnifier	273
Toilet bags	301, 371, 372, 373, 374, 375, 134, 138, 139, 140, 141, 142, 143
Tools Set	271
Toothbrush set	367
Toothbrushes	366, 367

Torch pen	94, 275
Touchscreen gloves	293
Towels	314, 336, 352
Travel mask	133
Travel pillows	370, 133
Trolley	119, 120, 122
U	
Umbrellas	296, 297, 298, 310
USB Car Charger	60
USB HUB	30, 35, 45
USB pendrive	66, 67, 68
USB port	30, 35, 45
Utility knives	277, 279
V	
Visor	314, 353
W	
Waistcoat	282
Walking Poles	345
Waste bags dispenser	286
Waterproof dry bags	341
Waterproof ponchos	294, 295
Weather station	21
Webcam cover	65
Whistle	320
Wine set	249, 250
Wireless chargers	15, 17, 29, 31, 32, 35, 37, 38, 44, 58
Wireless earphones	16, 25, 28, 39, 42, 43, 50, 51, 52, 53
Wireless Mouse	64, 65
Wireless power bank	29, 30, 38, 57
Wireless Speakers	17, 26, 27, 28, 34, 37, 39, 41, 42, 44, 46, 47, 48, 49
Wristbands	315, 351
Writing Set	73, 97
X	
XL Mouse pad	62, 312
Y	
Yoga mat	348, 349
Yoyo	257

COLOR CODES

COLOR	CODE
Aguamarine	236
Yellow	03
Hemp yellow	36
Fluor yellow	221
Heather fluor yellow	249
Golden yellow	96
Yellow corn	163
Angora (natural)	229
Tree	512
Sand	07
Dark sand	219
Denim Blue	86
Heather denim Blue	255
Electric Blue	99
Lab Blue	44
Washed Blue	126
Moonlight Blue	45
Navy Blue	55
Heather Navy Blue	247
Niagara Blue	43
Ocean Blue	100
Deep Blue	43
Riviera Blue	261
Bluish	65
Basketball	991
Bamboo	999
White	01
Pearl White	011
Blanco Vigoré	013
Burgundy	64
Borgoña Vigoré	238
Camel	85
Zebra	995
Sky Blue	10

COLOR	CODE
Chocolate	87
Copo	514
Fluor Coral	234
Heather Fluor Coral	244
Beige	29
Ebony	231
Heather Ebony	237
Star	511
Raspberry	72
France	158
Strawberry	84
Fuchsia	40
Football	992
Garnet	57
Heather Garnet	256
Heather Grey	58
Heather Light Grey	259
Dark Grey	59
Italy	161
Giraffe	997
Kiwi	990
Lime	225
Lime Yellow	118
Punch Lime	235
Heather Lime	250
Lemon	985
Apple	986
Brown	450
Mauve	63
Heather Mauve	253
Mustard	30
Heather Mustard	39
Orange	31
Naranja Bermillon	311

COLOR	CODE
Fluor Orange	223
Heather Orange	310
Black	02
Heather Black	243
Noel	515
Walnut	67
Nude	165
Gold	260
Rose Gold	281
Orchid	230
Oval	983
Fish	998
Pineapple	989
Pistachio	28
Silver	251
Lead	23
Dark Lead	46
Chicken	996
Portugal	162
Purple	71
Rectangular	981
Reno	513
Red	60
Chrysanthemum Red	262
Heather Red	245
Red Wine	116
Bubblegum Pink	34
Light Pink	48
Fluor Pink	228
Fluor Pink Lady	125
Rosette	78
Heather Rosette	252
Round	982
Royal	5

COLOR	CODE
Heather Royal	248
Watermelon	984
Snowman	516
Spain	157
Tennis	993
Tomato	987
Turquoise	12
Heather Turquoise	246
Grape	988
Bottle Green	56
Heather Bottle Green	257
Fluor Green	222
Grass Green	83
Fern Green	226
Heather Fern Green	135
Irish Green	24
Jungle Green	217
Khaki Green	13
Kelly Green	20
Lab Green	17
Mantis Green	69
Heather Mantis Green	693
Tide Green	041
Mint Green	98
Heather Mint Green	980
Army Green	15
Dark Army Green	38
Heather Army Green	153
Mist Green	264
Oasis Green	114
Sage Green	271
Path Green	124
Tropical Green	216
Wood	88

ICONOGRAPHY

 BOX	 PACK	 MEASURE	 PRINTING TECHNIQUES	 MADE TO ORDER
 BAMBOO	 RECYCLED PET	 GPS	 MESSAGE NOTIFY	 TABLET COMPARTMENT
 NATURAL JUTE	 RECYCLED ALUMINIUM	 TIME	 APP NOTIFY	 LAPTOP COMPARTMENT
 ORGANIC COTTON	 RECYCLED CARDBOARD	 APP	 FILE RECORDING	 WATERPROOF
 NATURAL WOOD	 SPEAKER	 4K 4K ULTRA HD	 DATA TRANSFER	 WATER RESIST
 NATURAL CORK	 WIRELESS CHARGER	 TACTILE	 POSITION RECORDING	 WINDPROOF
 LIMESTONE CEMENT	 RADIO FM	 TOUCH PEN	 HUMIDITY	 BPA FREE
 PLA	 WIFI	 MICRO SD	 TEMPERATURE	 ANTI PILLING
 TRITAN	 STEREO SOUND	 MICRO SIM	 HEART RATE MONITOR	 REFLECTIVE
 ANTIBACTERIAL ISO 22196	 BLUETOOTH	 CHARGER	 BLOOD PRESSURE	 REVERSIBLE
 WHEAT FIBER	 HANDS FREE	 FAST CHARGER	 OXYGEN PRESSURE	 DOUBLE WALL
 BAMBOO FIBER	 STOPWATCH	 ALARM	 RFID	 LINE IN
 BOROSILICATE GLASS	 PHONE CALLS	 LIGHT	 CALORIES COUNTER	 LIGHTNING
 HEMP	 MUSIC PLAYER	 COB LED	 PEDOMETER	 USB
 RECYCLED COTTON	 CALCULATOR	 BLINK	 SLEEP CONTROL	 USB TYPE C
 RECYCLED PAPER	 SOUND RECORDER	 CHANGING COLOR LIGHT	 SAFETY LOCK	 MICRO USB
 RECYCLED ABS (RABS)	 TIME & DATE	 VIBRATION	 BOTTLE POCKET	 FAIRTRADE COTTON

MARKING TECHNIQUES



Silk-screen printing



Sublimation



Sublimation mugs

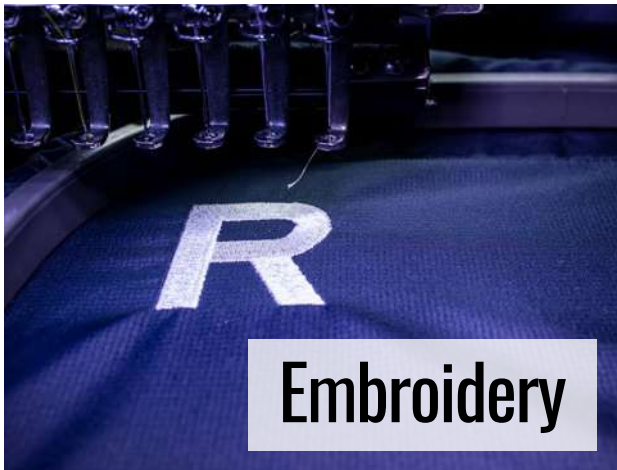

Embroidery



Transfers

Marking Code	Technique
A - K	Pad printing / Silk-screen printing
M	Offset
N	Serigraphic transfer
O	Digital transfer
Q	Sublimation mugs

R	Sublimation
T	Thermograved
U	Thermograved with colour tape
W	Digital printing
P	Embroidery
L	Laser

*We reserve the right to modify the print codes and/or number of colours published in this catalogue without prior notice.



Thermograved



Pad printing



Manipulated



Laser

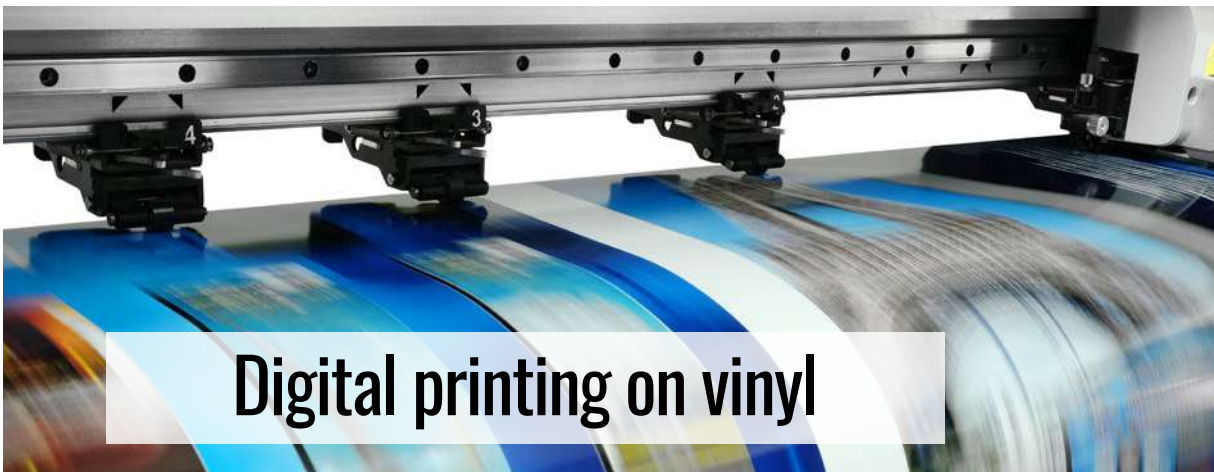

Digital printing on vinyl

**AN
UNLIMITED
PROMOTIONAL
WORLD**





Stamina

POWER IDEAS

PROMOTIONAL GIFTS